

E.2 SERIES CIRCULATORS

E23.2/E23.2B | SUBMITTAL

File No: 10.610
 Date: MAY 03, 2022
 Supersedes: 10.610
 Date: JUNE 05, 2017

Job: _____ Representative: _____
 _____ Order no.: _____ Date: _____
 Engineer: _____ Submitted by: _____ Date: _____
 Contractor: _____ Approved by: _____ Date: _____

QUANTITY	TAG NO.	PART NUMBER	FLOW (USgpm)	HEAD (FEET)	VOLTAGE	PHASE	COMMENTS

TECHNICAL DATA

Flow range: 0 to 83.0 USgpm (0 to 5.2 L/s)

Head range: 0 to 35.5 feet (0 to 10.8 m)

Max/Min fluid temp: 230°F/40°F (110°C/4°C)

Max. working pressure: 150 psi (1034 kPa)

MATERIALS OF CONSTRUCTION

Pump body: Cast iron (closed systems)
 Bronze (lead free for open systems)

Face plate: Stainless steel **Shaft:** Stainless steel

Impeller: 30% Glass-filled noryl **Volute gasket:** EPDM

Bearings: Permanently lubricated stainless steel

Seal: Silicon carbide enviroseal c/w viton elastomer

All Bronze Circulators are NSF - 372 rated

PART NUMBER

	120V	240V
E23.2	182212-651	182212-610
E23.2B	182212-652	182212-611

E23.2/E23.2B ACCESSORIES

- 1" Flange kits
- 1¼" Flange kits
- 1½" Flange kits
- Timer
- Aquastat

MOTOR DATA

Voltage	120V	208V	240V	277V
Full load amp draw	5.0A	2.6A	2.6A	2.6A

Nominal power: ¾ hp (300W)

Frequency: 60 Hz

Motor type: Two pole, Single phase ODP

Speed: 3400 rpm

MOUNTING ORIENTATION FOR INDOOR USE ONLY

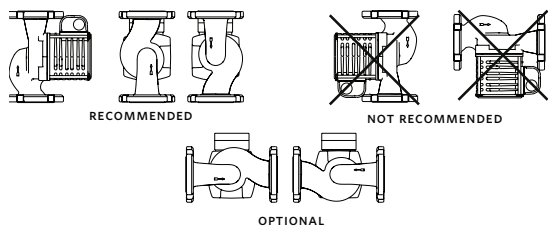

PERFORMANCE CURVE

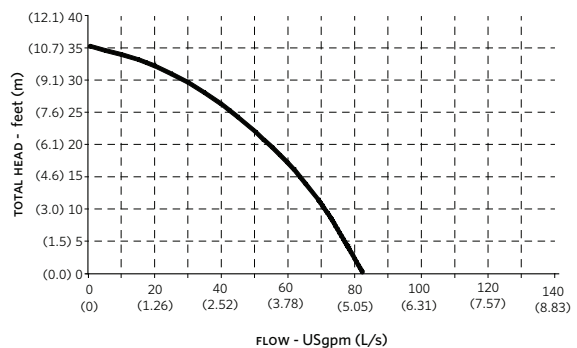

Performance curves are for reference only. Confirm current performance data with Armstrong ACE ONLINE selection software.

DIMENSIONS inches (mm)									SHIP. WEIGHT
MODEL	BODY	A	B	C	D	E	F	CASING FLANGE SIZE & TYPE	lbs (kgs)
E23.2	Cast iron	10.30 (261)	8.50 (215)	8.00 (202)	4.00 (101)	3.40 (86)	4.20 (107)	1.5" diameter 2-bolt flanges	20.7 (9.39)
E23.2B	Bronze	10.30 (261)	8.50 (215)	8.00 (202)	4.00 (101)	3.40 (86)	4.20 (107)	1.5" diameter 2-bolt flanges	20.9 (9.48)

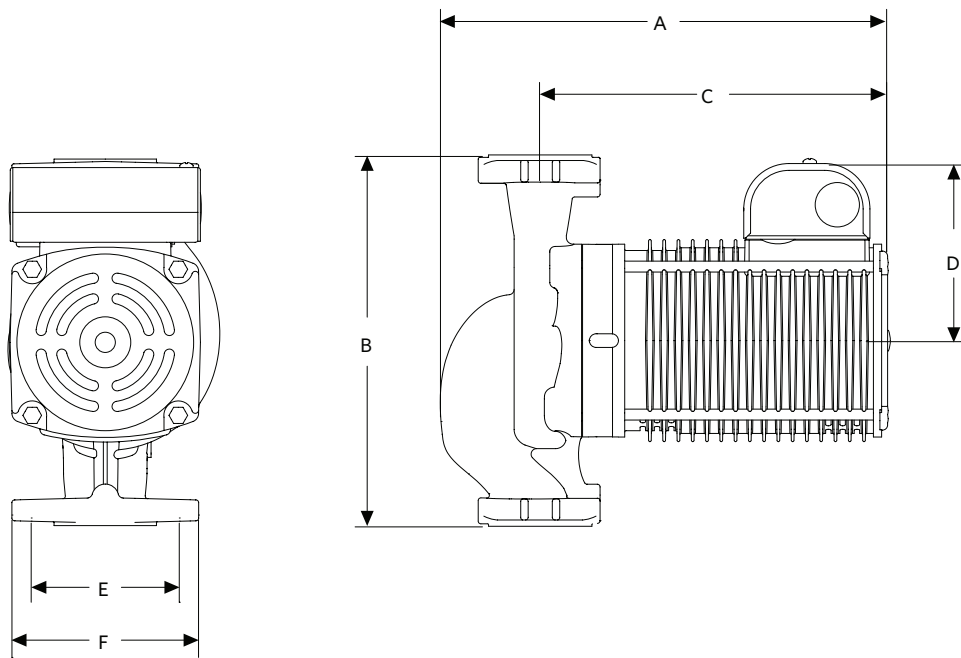

TORONTO
+1 416 755 2291

BUFFALO
+1 716 693 8813

DROITWICH SPA
+44 8444 145 145

MANCHESTER
+44 8444 145 145

BANGALORE
+91 80 4906 3555

SHANGHAI
+86 21 5237 0909

SÃO PAULO
+55 11 4785 1330

LYON
+33 4 26 83 78 74

DUBAI
+971 4 887 6775

MANNHEIM
+49 621 3999 9858

JIMBOLIA
+40 256 360 030