

## DESIGN ENVELOPE 4382 DUALARM | 0811-007.5 | SUBMITTAL

File No: 100.4658  
 Date: OCTOBER 30, 2015  
 Supersedes: NEW  
 Date: NEW

Job: \_\_\_\_\_ Representative: \_\_\_\_\_

Order No: \_\_\_\_\_ Date: \_\_\_\_\_

Engineer: \_\_\_\_\_ Submitted by: \_\_\_\_\_ Date: \_\_\_\_\_

Contractor: \_\_\_\_\_ Approved by: \_\_\_\_\_ Date: \_\_\_\_\_

### PUMP DESIGN DATA

No. of pumps: \_\_\_\_\_ Tag: \_\_\_\_\_

Capacity: \_\_\_\_\_ USgpm (L/s) Head: \_\_\_\_\_ ft (m)

Liquid: \_\_\_\_\_ Viscosity: \_\_\_\_\_

Temperature: \_\_\_\_\_ °F (°C) Specific gravity: \_\_\_\_\_

Suction: 8" (200mm) Discharge: 8" (200mm)

**OSHPD Seismic Certification OSP-0422-10**

**UL STD 778 & CSA STD C22.2 NO.108 certified**

### MOTOR DESIGN DATA

HP: \_\_\_\_\_ RPM: \_\_\_\_\_ Frame size: \_\_\_\_\_ Enclosure: \_\_\_\_\_

Volts: \_\_\_\_\_ Hertz: 60 Hz Phase: 3

Efficiency: NEMA premium 12.12

### MAXIMUM PUMP OPERATING CONDITIONS

#### ANSI 125

175 psig at 150°F (12 bars at 65°C)

140 psig at 250°F (10 bars at 121°C)

#### ANSI 250

250 psig at 150°F (17 bars at 65°C)

250 psig at 250°F (17 bars at 121°C)

- Tolerance of ±0.125" (±3 mm) should be used
- For exact installation, data please write factory for certified dimensions

### MECHANICAL SEAL DATA

Seal Type: 2A Stationary Seat: Silicon carbide

Secondary Seal: EPDM Rotating Hardware: Stainless steel

Spring: Stainless steel

### CONTROLS DATA

Sensorless Control: Standard

Minimum system pressure to be maintained: \_\_\_\_\_ ft (m)\*

Protocol (standard):  Modbus RTU  BACnet™ MS/TP  
 Johnson® N2  Siemens® FLN

Protocol (optional):  LonWorks®

Enclosure:  Indoor - UL TYPE 12  
 Outdoor - UL TYPE 4X with Weather Shield  
 Outdoor - UL TYPE 4X less Weather Shield

Fused disconnect switch:

Duty/standby pre-wired bridge:

EMI/RFI control: Integrated filter designed to meet EN61800-3

Harmonic suppression: Dual dc-link reactors (Equivalent: 5% AC line reactor) Supporting IEEE 519-1992 requirements\*\*

Cooling: Fan-cooled through back channel

Ambient temperature: -10°C to +45°C up to 1000 meters above sea level (-14°F to +113°F, 3300 ft)

Analog I/O: Two current or voltage inputs, one current output

Digital I/O: Six programmable inputs (two can be configured as outputs)

Pulse inputs: Two programmable

Relay outputs: Two programmable

Communication port: 1-RS485, 1-USB

\*If minimum maintained system pressure is not known: Default to 40% of design head

\*\*The Ivs 102 drive is a low harmonic drive via built-in dc line reactors. This does not guaranty performance to any system wide harmonic specification or the costs to meet a system wide specification. If supplied with the system electrical details, Armstrong will run a computer simulation of the system wide harmonics. If system harmonic levels are exceeded Armstrong can also recommend additional harmonic mitigation and the costs for such mitigation.

FLUID TYPE	ALL GLYCOLS > 30% WT CONC		ALL OTHER NON-POTABLE FLUIDS		POTABLE (DRINKING) WATER	
Temperature	up to 200°F / 93°C	over 200°F / 93°C	up to 200°F / 93°C	over 200°F / 93°C	up to 200°F / 93°C	over 200°F / 93°C
Rotating Face	Silicon carbide		Resin bonded carbon	Antimony loaded carbon	Resin bonded carbon	
Seat Elastomer	EPDM (L-cup)	EPDM (O-ring)	EPDM (L-cup)	EPDM (O-ring)	EPDM (L-cup)	EPDM (O-ring)
Material Code	SCsc L EPSS 2A	SCsc O EPSS 2A	C-sc L EPSS 2A	ACsc O EPSS 2A	C-sc L EPSS 2A	C-sc O EPSS 2A

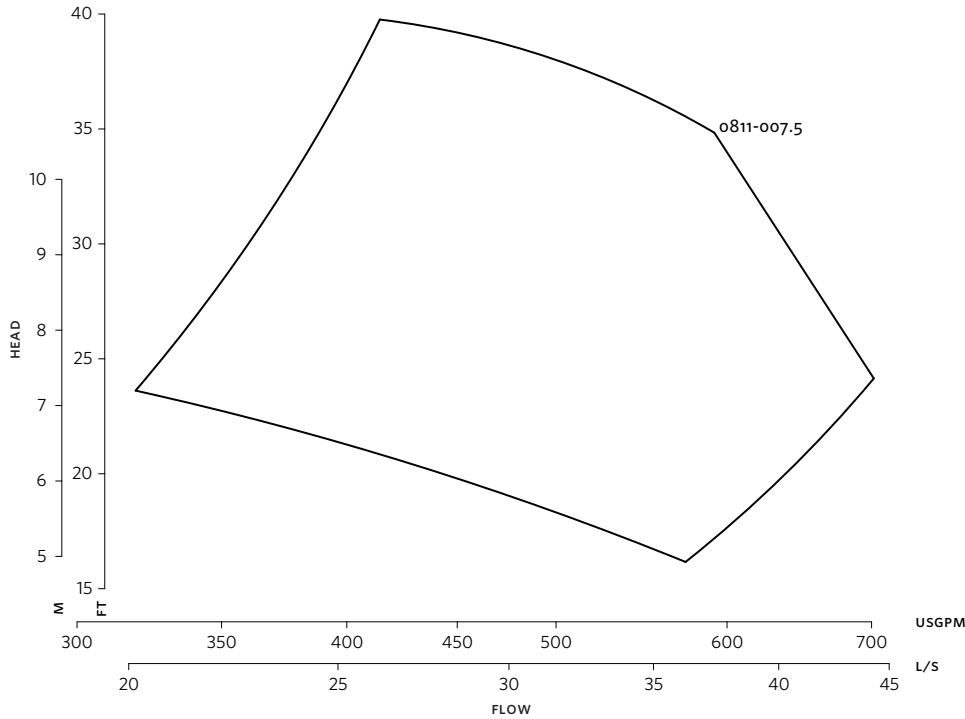

**DIMENSION DATA**

	INDOOR (UL TYPE 12/ODP)	OUTDOOR (UL TYPE 4X/TEFC)
<b>Frame size:</b>	254	254
<b>Size:</b>	8×8×11	8×8×11
<b>HP:</b>	7.5	7.5
<b>RPM:</b>	1500	1500
<b>AB:</b>	24.95(634)	24.95(634)
<b>B1:</b>	10.50(267)	10.50(267)
<b>B2:</b>	11.00(279)	11.00(279)
<b>C1:</b>	20.10(511)	20.10(511)
<b>C2:</b>	20.23(514)	20.23(514)
<b>D1:</b>	21.46(545)	21.46(545)
<b>D2:</b>	26.30(668)	26.30(668)
<b>E:</b>	9.94(252)	9.94(252)
<b>F:</b>	17.96(456)	17.96(456)
<b>P:</b>	14.19(360)	14.19(360)
<b>SD:</b>	46.94(1192)	46.94(1192)
<b>T:</b>	8.80(224)	8.80(224)
<b>XY:</b>	27.26(692)	27.26(692)
<b>Weight:</b>	1604(727.6)	1684(763.9)

Performance curves are for reference only.  
Confirm current performance data with Armstrong ACE Online selection software.

Dimensions - inch (mm)  
Weight - lbs (kg)

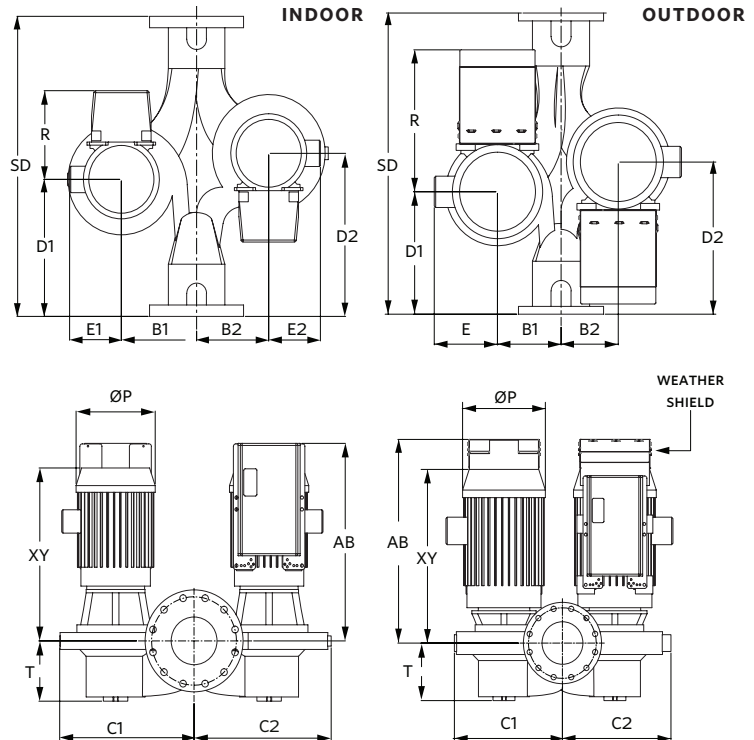

**TORONTO**  
+1 416 755 2291

**BUFFALO**  
+1 716 693 8813

**BIRMINGHAM**  
+44 (0) 8444 145 145

**MANCHESTER**  
+44 (0) 8444 145 145

**BANGALORE**  
+91 (0) 80 4906 3555

**SHANGHAI**  
+86 21 3756 6696