

# DESIGN ENVELOPE 4380 VIL

## SINGLE PHASE | 0208-005.0 | SUBMITTAL

File No: 100.4388  
 Date: OCTOBER 27, 2014  
 Supersedes: NEW  
 Date: NEW

Job: \_\_\_\_\_ Representative: \_\_\_\_\_  
 \_\_\_\_\_ Order No: \_\_\_\_\_ Date: \_\_\_\_\_  
 Engineer: \_\_\_\_\_ Submitted by: \_\_\_\_\_ Date: \_\_\_\_\_  
 Contractor: \_\_\_\_\_ Approved by: \_\_\_\_\_ Date: \_\_\_\_\_

### PUMP DESIGN DATA

No. of pumps: \_\_\_\_\_ Tag: \_\_\_\_\_  
 Capacity: \_\_\_\_\_ USgpm (L/s) Head: \_\_\_\_\_ ft (m)  
 Liquid: \_\_\_\_\_ Viscosity: \_\_\_\_\_  
 Temperature: \_\_\_\_\_ °F (°C) Specific gravity: \_\_\_\_\_  
 Suction: 2" (50mm) Discharge: 2" (50mm)

### MOTOR DESIGN DATA

HP: 5 RPM: 1825 Frame size: \_\_\_\_\_  
 Enclosure: \_\_\_\_\_ Volts: 208 Freq: 60 Hz  
 Phase: 3 Efficiency: NEMA premium 12.12

### MAXIMUM PUMP OPERATING CONDITIONS

#### ANSI 125

175 psig at 150°F (12 bars at 65°C)  
 140 psig at 250°F (10 bars at 121°C)

#### ANSI 250

300 psig at 150°F (20 bars at 65°C)  
 250 psig at 250°F (17 bars at 121°C)

- Tolerance of ±0.125" (±3 mm) should be used
- For exact installation, data please write factory for certified dimensions

### MECHANICAL SEAL DATA

Seal type: 2A  
 Stationary seat: Silicone carbide  
 Secondary seal: EPDM  
 Rotating hardware: Stainless steel  
 Spring: Stainless steel

### CONTROLS DATA

**Power supply:** Volts: 200-240VAC  
 Freq: 50/60Hz Phase: 1

**Sensorless control:** Standard

**Minimum system pressure to be maintained:** \_\_\_\_\_ ft (m)\*

**Orientation:**  L1 (default)  L2  L3  L4

**Protocol (standard):**  Modbus RTU  BACnet™ MS/TP  
 Johnson® N2  Siemens® FLN

**Protocol (optional):**  LonWorks®

**Enclosure:**  Indoor - UL TYPE 12  
 Outdoor - UL TYPE 4X with weather shield  
 Outdoor - UL TYPE 4X less weather shield

**Disconnect switch:**  Non-fused

**EMI/RFI control:** 1-phase IVS102 units do not meet the EN61800-3 directive

**Harmonic suppression:** Dual DC-link reactors (equivalent: 5% AC line reactor) supporting IEEE 519-1992 requirements\*\*

**Cooling:** Fan-cooled through back channel

**Ambient temperature:** -10°C to +45°C up to 1000 meters above sea level (-14°F to +113°F, 3300 ft)

**Analog i/o:** Two current or voltage inputs, one current output

**Digital i/o:** Six programmable inputs (two can be configured as outputs)

**Pulse inputs:** Two programmable

**Relay outputs:** Two programmable

**Communication port:** 1-RS485, 1-USB

\*If minimum maintained system pressure is not known: Default to 40% of design head  
 \*\*The IVS102 drive is a low harmonic drive via built-in DC line reactors. This does not guaranty performance to any system wide harmonic specification or the costs to meet a system wide specification. If supplied with the system electrical details, Armstrong will run a computer simulation of the system wide harmonics. If system harmonic levels are exceeded Armstrong can also recommend additional harmonic mitigation and the costs for such mitigation.

FLUID TYPE	ALL GLYCOLS > 30% WT CONC		ALL OTHER NON-POTABLE FLUIDS		POTABLE (DRINKING) WATER	
Temperature	up to 200°F / 93°C	over 200°F / 93°C	up to 200°F / 93°C	over 200°F / 93°C	up to 200°F / 93°C	over 200°F / 93°C
Rotating face	Silicone carbide		Resin bonded carbon	Antimony loaded carbon	Resin bonded carbon	
Seat elastomer	EPDM (L-cup)	EPDM (O-ring)	EPDM (L-cup)	EPDM (O-ring)	EPDM (L-cup)	EPDM (O-ring)
Material code	SCSc L EPSS 2A	SCSc O EPSS 2A	C-Sc L EPSS 2A	ACSc O EPSS 2A	C-Sc L EPSS 2A	C-Sc O EPSS 2A

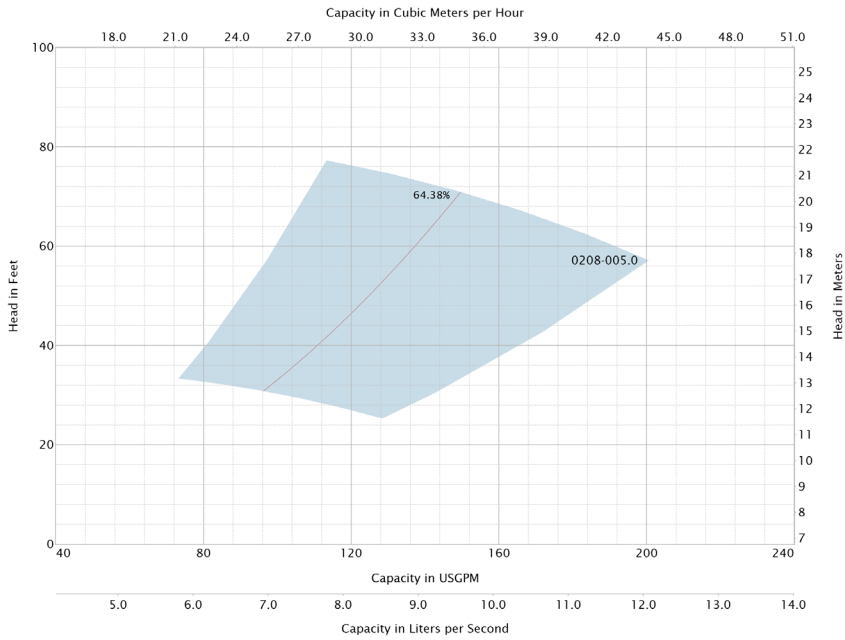

**DIMENSION DATA**

	INDOOR (UL TYPE 12/ODP)	OUTDOOR (UL TYPE 4X/TEFC)
<b>Frame size:</b>	184	184
<b>Size:</b>	2×2×8	2×2×8
<b>HP:</b>	5	5
<b>RPM:</b>	1825	1825
<b>AB:</b>	23.28(591)	29.31(745)
<b>B:</b>	5.80(147)	5.80(147)
<b>C:</b>	5.80(147)	5.80(147)
<b>D:</b>	8.50(216)	8.50(216)
<b>E:</b>	14.42(366)	17.91(455)
<b>F:</b>	14.42(366)	17.91(455)
<b>P:</b>	10.38(264)	9.50(241)
<b>S:</b>	9.50(241)	9.50(241)
<b>SD:</b>	18.00(457)	18.00(457)
<b>T:</b>	5.09(129)	5.09(129)
<b>XY:</b>	19.26(489)	20.01(508)
<b>Weight:</b>	261(118.4)	289(131.1)

Performance curves are for reference only.  
Confirm current performance data with Armstrong ACE Online selection software.

Dimensions - inch (mm)  
Weight - lbs (kg)

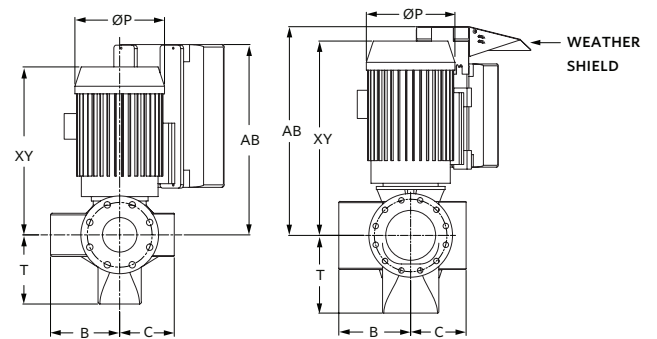
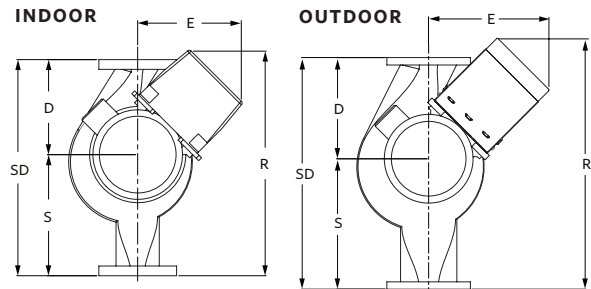
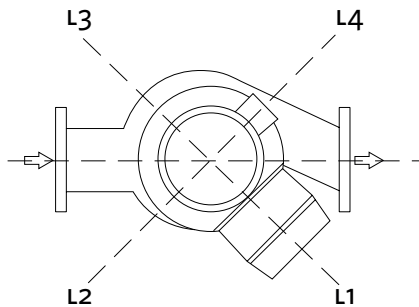

**TORONTO**  
+416 755 2291

**BUFFALO**  
+716 693 8813

**BIRMINGHAM**  
+44 (0) 8444 145 145

**MANCHESTER**  
+44 (0) 8444 145 145

**BANGALORE**  
+91 (0) 80 4906 3555

**SHANGHAI**  
+86 21 3756 6696