

DESIGN ENVELOPE 4380 VIL | 0408-003.0 | SUBMITTAL

File No: 100.4346
Date: JANUARY 14, 2016
Supersedes: NEW
Date: NEW

Job: _____ Representative: _____

Order No: _____ Date: _____

Engineer: _____ Submitted by: _____ Date: _____

Contractor: _____ Approved by: _____ Date: _____

PUMP DESIGN DATA

No. of pumps: _____ Tag: _____

Capacity: _____ USgpm (L/s) Head: _____ ft (m)

Liquid: _____ Viscosity: _____

Temperature: _____ °F (°C) Specific gravity: _____

Suction: 4" (100mm) Discharge: 4" (100mm)

OSHPD Seismic Certification OSP-0422-10

UL STD 778 & CSA STD C22.2 NO.108 certified

MOTOR DESIGN DATA

hp: _____ rpm: _____ Frame size: _____ Enclosure: _____

Volts: _____ Hertz: 60 Hz Phase: 3

Efficiency: NEMA premium 12.12

MAXIMUM PUMP OPERATING CONDITIONS

ANSI 125

175 psig at 150°F (12 bars at 65°C)

140 psig at 250°F (10 bars at 121°C)

ANSI 250

300 psig at 150°F (20 bars at 65°C)

250 psig at 250°F (17 bars at 121°C)

- Tolerance of ±0.125" (±3 mm) should be used
- For exact installation, data please write factory for certified dimensions

MECHANICAL SEAL DATA

Seal type: 2A

Stationary seat: Silicone carbide

Secondary seal: EPDM

Rotating hardware: Stainless steel

Spring: Stainless steel

CONTROLS DATA

Sensorless control: Standard

Minimum system pressure to be maintained: _____ ft (m)*

Orientation: L1 (default) L2 L3 L4

Protocol (standard): Modbus RTU BACnet™ MS/TP
 Johnson® N2 Siemens® FLN

Protocol (optional): LonWorks®

Enclosure: Indoor - UL TYPE 12
 Outdoor - UL TYPE 4X with weather shield
 Outdoor - UL TYPE 4X less weather shield

Fused disconnect switch:

EMI/RFI control: Integrated filter designed to meet EN61800-3

Harmonic suppression: Dual DC-link reactors (equivalent: 5% AC line reactor) supporting IEEE 519-1992 requirements**

Cooling: Fan-cooled through back channel

Ambient temperature: -10°C to +45°C up to 1000 meters above sea level (-14°F to +113°F, 3300 ft)

Analog I/O: Two current or voltage inputs, one current output

Digital I/O: Six programmable inputs (two can be configured as outputs)

Pulse inputs: Two programmable

Relay outputs: Two programmable

Communication port: 1-RS485, 1-USB

*If minimum maintained system pressure is not known: Default to 40% of design head

**The IVS 102 drive is a low harmonic drive via built-in DC line reactors. This does not guaranty performance to any system wide harmonic specification or the costs to meet a system wide specification. If supplied with the system electrical details, Armstrong will run a computer simulation of the system wide harmonics. If system harmonic levels are exceeded Armstrong can also recommend additional harmonic mitigation and the costs for such mitigation.

FLUID TYPE	ALL GLYCOLS > 30% WT CONC		ALL OTHER NON-POTABLE FLUIDS		POTABLE (DRINKING) WATER	
Temperature	up to 200°F / 93°C	over 200°F / 93°C	up to 200°F / 93°C	over 200°F / 93°C	up to 200°F / 93°C	over 200°F / 93°C
Rotating face	Silicone carbide		Resin bonded carbon	Antimony loaded carbon	Resin bonded carbon	
Seat elastomer	EPDM (L-cup)	EPDM (O-ring)	EPDM (L-cup)	EPDM (O-ring)	EPDM (L-cup)	EPDM (O-ring)
Material code	SCSc L EPSS 2A	SCSc O EPSS 2A	C-SC L EPSS 2A	ACSc O EPSS 2A	C-SC L EPSS 2A	C-SC O EPSS 2A

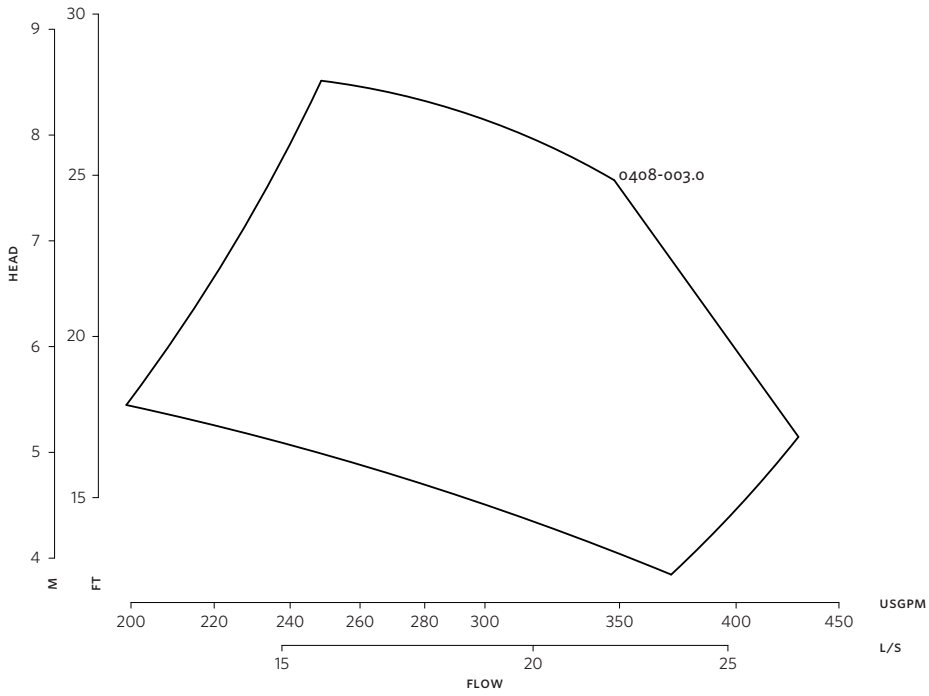

DIMENSION DATA

	INDOOR (UL TYPE 12/ODP)	OUTDOOR (UL TYPE 4X/TEFC)
Frame size:	213	213
Size:	4×4×8	4×4×8
HP:	3	3
RPM:	1500	1500
AB:	27.37(695)	27.37(695)
B:	8.89(226)	8.89(226)
C:	6.80(173)	6.80(173)
D:	11.00(279)	11.00(279)
E:	14.95(380)	14.95(380)
F:	14.95(380)	14.95(380)
P:	11.25(286)	11.25(286)
S:	14.00(356)	14.00(356)
SD:	25.00(635)	25.00(635)
T:	8.00(203)	8.00(203)
XY:	26.77(680)	26.77(680)
Weight:	410(186.0)	431(195.3)

Performance curves are for reference only.
Confirm current performance data with Armstrong ACE Online selection software.

Dimensions - inch (mm)
Weight - lbs (kg)

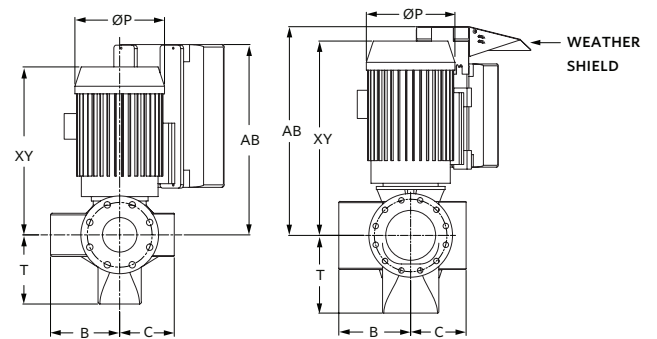
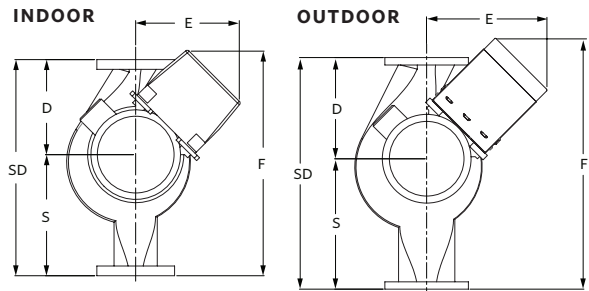
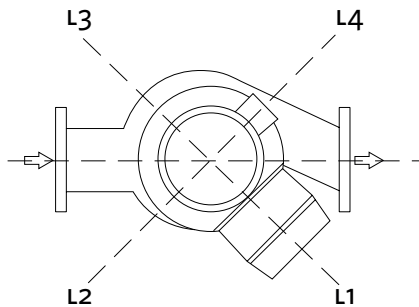

TORONTO
+1 416 755 2291

BUFFALO
+1 716 693 8813

BIRMINGHAM
+44 (0) 8444 145 145

MANCHESTER
+44 (0) 8444 145 145

BANGALORE
+91 (0) 80 4906 3555

SHANGHAI
+86 21 3756 6696