

# AGE4 CIRCULATOR | SINGLE-HEAD VARIABLE SPEED | 50-80Z | SUBMITTAL

File No: 10.8562IEC  
Date: SEPTEMBER 30, 2022  
Supersedes: 10.8562IEC  
Date: FEBRUARY 25, 2020

Job: \_\_\_\_\_ Representative: \_\_\_\_\_  
 \_\_\_\_\_ Ordered by: \_\_\_\_\_ Date: \_\_\_\_\_  
 Engineer: \_\_\_\_\_ Submitted by: \_\_\_\_\_ Date: \_\_\_\_\_  
 Contractor: \_\_\_\_\_ Approved by: \_\_\_\_\_ Date: \_\_\_\_\_

## PUMP DETAILS

TAG	MODEL	FLOW	HEAD	SYSTEM	LOCATION

### MOTOR DESIGN DATA

**Motor enclosure:** IP44  
**Power supply:** 230/1/50  
**Insulation class:** F  
**Motor efficiency:**  $EEI \leq 0.22$   
**Inverter/motor type:** ECM/Permanent magnet  
**Motor speed:** Variable speed

### ELECTRICAL DATA

1x230,50HZ, IEC38	P1[W]	I [AMPS]
Auto min.	25	2.6
Auto max.	270	3.8

### ELECTRICAL CONNECTION

**Type:** 3 wires (L,N,Earth)  
**Connector:** 3 pins connector & cable gland

### BMS CONNECTIVITY

**Input/output:** 1 x analogue I/O, 1 x digital I/O and 2 x relay  
**Serial communication:** Modbus RTU, Modbus TCP/IP, BACnet MS/TP

### MATERIALS OF CONSTRUCTION

**Impeller:** PES  
**Casing gasket:** EPDM 70 Shore  
**Bearings:** Graphite  
**Pump casing:** Bronze  
**Shaft:** Stainless steel  
**Can:** Stainless steel

### MECHANICAL CONNECTION

**Type:** Flanged  
**Pressure rating:** PN6/10  
**Size:** DN50

### ENVIRONMENT LIMIT DATA

**Water temp max:** 110°C  
**Water temp min :** 2°C  
**Ambient temp. max:** 40°C  
**Min. pressure:** 0.05 bar < 75°C,  
 0.28 bar < 90°C

**DIMENSIONS**

A	B	C	D	E	WEIGHT
mm (inches)					kg (lbs)
287 (11.3)	72 (2.8)	280 (11.0)	80.5 (3.2)	92 (3.6)	15.5 (34.2)

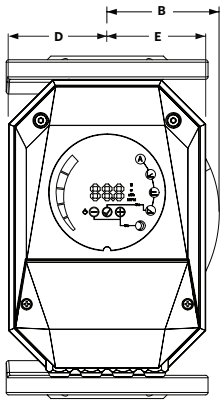

H (kpa)

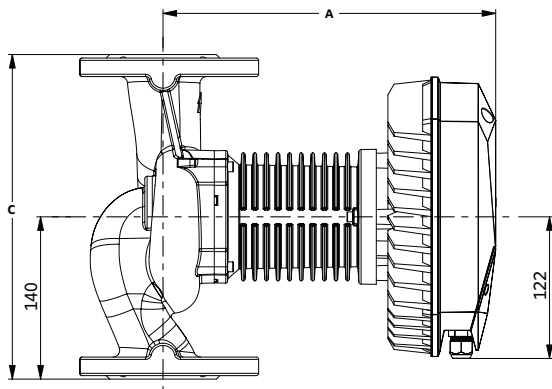
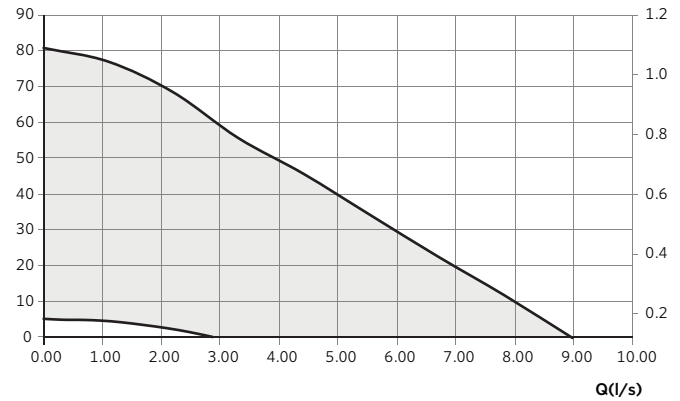

P (W)

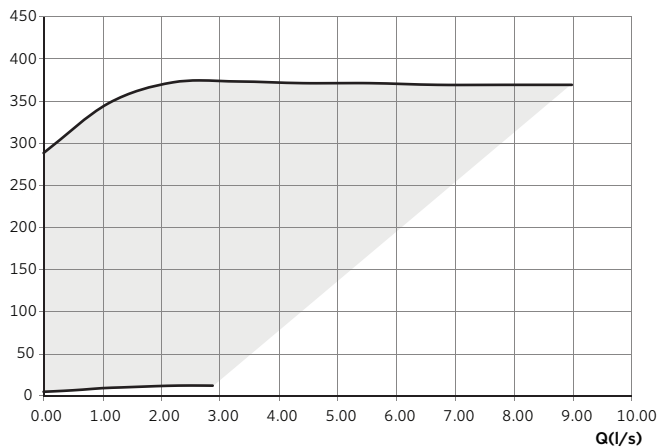

**TORONTO**

+1 416 755 2291

**BUFFALO**

+1 716 693 8813

**DROITWICH SPA**

+44 8444 145 145

**MANCHESTER**

+44 8444 145 145

**BANGALORE**

+91 80 4906 3555

**SHANGHAI**

+86 21 5237 0909

**BEIJING**

+86 21 5237 0909

**SÃO PAULO**

+55 11 4785 1330

**LYON**

+33 4 26 83 78 74

**DUBAI**

+971 4 887 6775

**MANNHEIM**

+49 621 3999 9858

**JIMBOLIA**

+40 256 360 030

