

AGE4 CIRCULATOR | SINGLE-HEAD VARIABLE SPEED | 25-60Z | SUBMITTAL

File No: 10.8524IEC
Date: SEPTEMBER 30, 2022
Supersedes: 10.8524IEC
Date: FEBRUARY 25, 2020

Job: _____ Representative: _____
 _____ Ordered by: _____ Date: _____
 Engineer: _____ Submitted by: _____ Date: _____
 Contractor: _____ Approved by: _____ Date: _____

PUMP DETAILS

TAG	MODEL	FLOW	HEAD	SYSTEM	LOCATION

MOTOR DESIGN DATA

Motor enclosure: IP44
Power supply: 230/1/50
Insulation class: F
Motor efficiency: $EEI \leq 0.21$
Inverter/motor type: ECM/Permanent magnet
Motor speed: Variable speed

ELECTRICAL DATA

1x230,50HZ, IEC38	P1[W]	I [AMPS]
Auto min.	7	0.10
Auto max.	90	0.75

ELECTRICAL CONNECTION

Type: 3 wires (L,N,Earth)
Connector: 3 pins connector & cable gland

BMS CONNECTIVITY

Input/output: 1 x analogue I/O, 1 x digital I/O and 1 x relay
Serial communication: Modbus RTU and Ethernet

MATERIALS OF CONSTRUCTION

Impeller: PES
Casing gasket: EPDM 70 Shore
Bearings: Graphite
Pump casing: Bronze
Shaft: Stainless steel
Can: Stainless steel

MECHANICAL CONNECTION

Type: Threaded
Pressure rating: PN10
Size: G1½"

ENVIRONMENT LIMIT DATA

Water temp max: 110°C
Water temp min : 2°C
Ambient temp. max: 40°C
Min. pressure: 0.05 bar < 75°C,
 0.28 bar < 90°C

DIMENSIONS

A	B	C	D	E	WEIGHT
mm (inches)					kg (lbs)
180 (7.1)	95 (3.7)	180 (7.1)	58.5 (2.3)	58.5 (2.3)	3.5 (7.7)

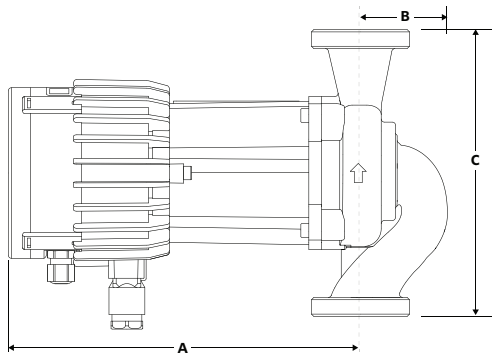
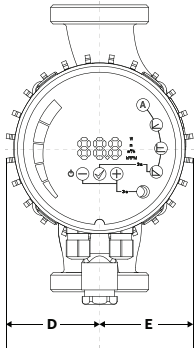

H (kpa)

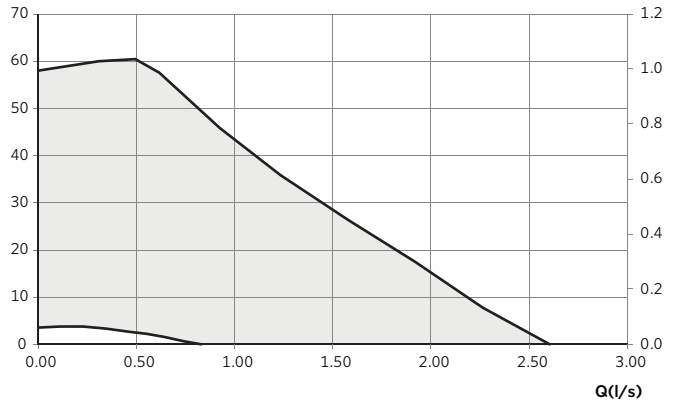

P (W)

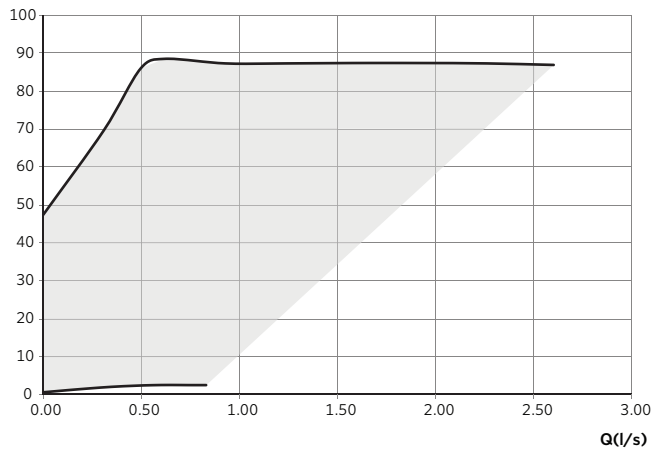

TORONTO

+1 416 755 2291

BUFFALO

+1 716 693 8813

DROITWICH SPA

+44 8444 145 145

MANCHESTER

+44 8444 145 145

BANGALORE

+91 80 4906 3555

SHANGHAI

+86 21 5237 0909

BEIJING

+86 21 5237 0909

SÃO PAULO

+55 11 4785 1330

LYON

+33 4 26 83 78 74

DUBAI

+971 4 887 6775

MANNHEIM

+49 621 3999 9858

JIMBOLIA

+40 256 360 030