

AGE3D CIRCULATOR | TWIN HEAD VARIABLE SPEED | 32-120 | SUBMITTAL

File No: 10.8586IEC
Date: FEBRUARY 25, 2020
Supersedes: 10.8586IEC
Date: MAY 10, 2017

Job: _____ Representative: _____
 _____ Ordered by: _____ Date: _____
 Engineer: _____ Submitted by: _____ Date: _____
 Contractor: _____ Approved by: _____ Date: _____

PUMP DETAILS

TAG	MODEL	FLOW	HEAD	SYSTEM	LOCATION

MOTOR DESIGN DATA

Motor enclosure: IP44
Power supply: 230/1/50
Insulation class: F
Motor efficiency: $EEI \leq 0.22$
Inverter/motor type: ECM/Permanent magnet
Motor speed: Variable speed

ELECTRICAL DATA

1x230,50HZ, IEC38	P1[W]	I [AMPS]
Auto min.	25	2.6
Auto max.	480	1.5

ELECTRICAL CONNECTION

Type: 3 wires (L,N,Earth)
Connector: 3 pins connector & cable gland

BMS CONNECTIVITY

Input/output: 1 x analogue I/O, 1 x digital I/O and 1 x relay
Serial communication: Modbus RTU and Ethernet

MATERIALS OF CONSTRUCTION

Impeller: PES
Casing gasket: EPDM 70 Shore
Bearings: Graphite
Pump casing: Cast iron
Shaft: Stainless steel
Can: Stainless steel

MECHANICAL CONNECTION

Type: Flanged
Pressure rating: PN6/10
Size: DN32

ENVIRONMENT LIMIT DATA

Water temp max: 110°C
Water temp min : 2°C
Ambient temp. max: 40°C
Min. pressure: 0.05 BAR < 75°C,
 0.28 BAR < 90°C

DIMENSIONS

A	B	C	D	E	WEIGHT
mm (inches)					kg (lbs)
297 (11.7)	65 (2.5)	220 (8.7)	185 (7.3)	186 (7.3)	22 (48.5)

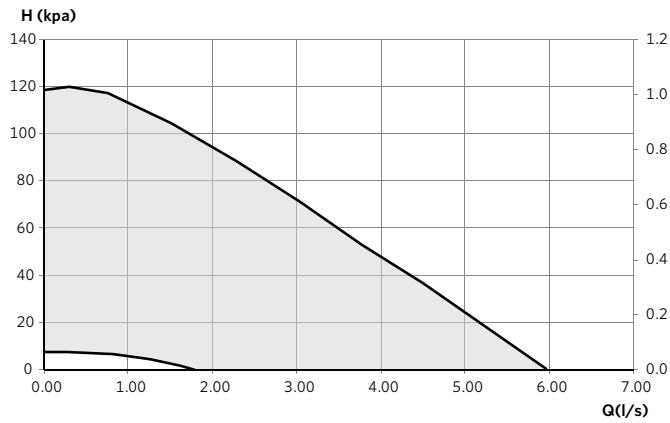
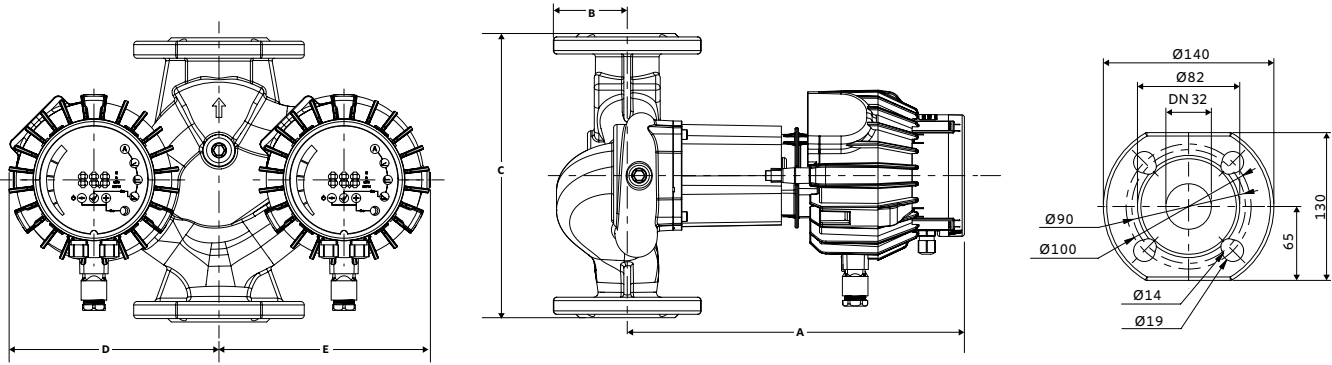

TORONTO
+1 416 755 2291

BUFFALO
+1 716 693 8813

BIRMINGHAM
+44 (0) 8444 145 145

MANCHESTER
+44 (0) 8444 145 145

BANGALORE
+91 (0) 80 4906 3555

SHANGHAI
+86 (0) 21 5237 0909

SÃO PAULO
+55 11 4785 1330

LYON
+33 (0) 420 102 625

DUBAI
+971 4 887 6775

MANNHEIM
+49 (0) 621 3999 9858

