

ARMflo E Series Circulators - Models E13/E13B

SUBMITTAL



JOB/PROJECT: _____
 REPRESENTATIVE: _____
 ENGINEER: _____
 CONTRACTOR: _____
 ORDER NO: _____ DATE: _____
 SUBMITTED BY: _____ DATE: _____
 APPROVED BY: _____ DATE: _____

Quantity	TAG No.	Part No.	Flow (USgpm)	Head (feet)	Voltage	Phase	Comments

TECHNICAL DATA	
Flow Range	0 to 54.0 USgpm (0 to 3.4 L/s)
Head Range	0 to 19.7 feet (0 to 6.0 m)
Max. Fluid Temperature	230°F (110°C)
Max. Working Pressure	150 psi (1034 kPa)

MOTOR DATA	
Nominal Power	1/6 hp (125 W)
Voltage	120 V 240 V
Full Load Amp Draw	2.0 A 1.0 A
Frequency	60 Hz
Motor Type	2 pole, Single Phase
Speed	3400 rpm

MATERIALS OF CONSTRUCTION			
Pump Body	Cast Iron (closed systems)	Bronze (open systems)	Lead Free Bronze*
Face Plate	Stainless Steel		
Impeller	30% Glass-filled Noryl		
Shaft	Stainless Steel		
Bearings	Permanently lubricated Stainless Steel		
Volute Gasket	EPDM		
Seal	Silicon Carbide <i>EnviroSeal</i> c/w viton elastomer		

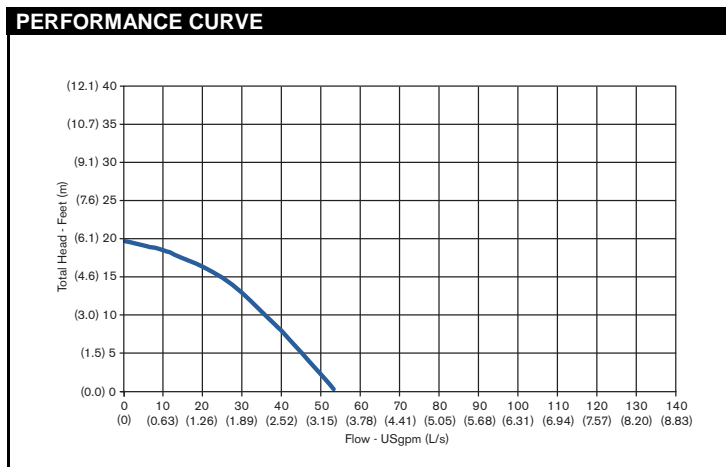
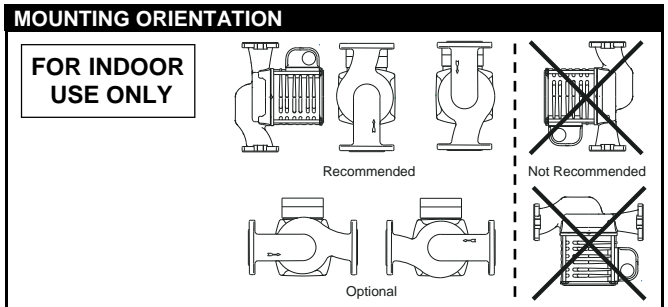

PART NUMBER		
	120 V	240 V
E13	180200-655	180200-667
E13B	180200-656	180200-668
E13B	180200LF-656	180200LF-668

E13/E13B ACCESSORIES	
1" Flange kits	Timer
1¼" Flange kits	Aquastat
1½" Flange kits	Spool Pieces

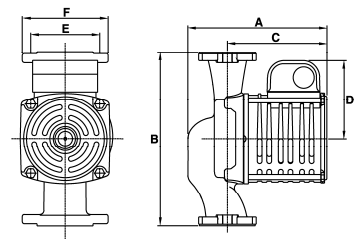

DIMENSIONS AND WEIGHTS									
Model	Body	A	B	C	D	E	F	Connection Type & Size	Shipping Weight
ARMflo E13	Cast Iron	6.8 (174)	8.5 (215)	4.9 (125)	3.8 (97)	3.4 (86)	4.2 (107)	1.5" diameter 2-bolt flanges	13.0 (5.9)
ARMflo E13B	Bronze /LF Bronze*	6.8 (174)	8.5 (215)	4.9 (125)	3.8 (97)	3.4 (86)	4.2 (107)	1.5" diameter 2-bolt flanges	14.8 (6.7)

Note: All dimensions are in inches (mm) and weights in lbs (kg)
 *Contains less than 0.25% lead, weighted average.



ARMflo E Series Circulators

COMPOSITE PERFORMANCE CURVES

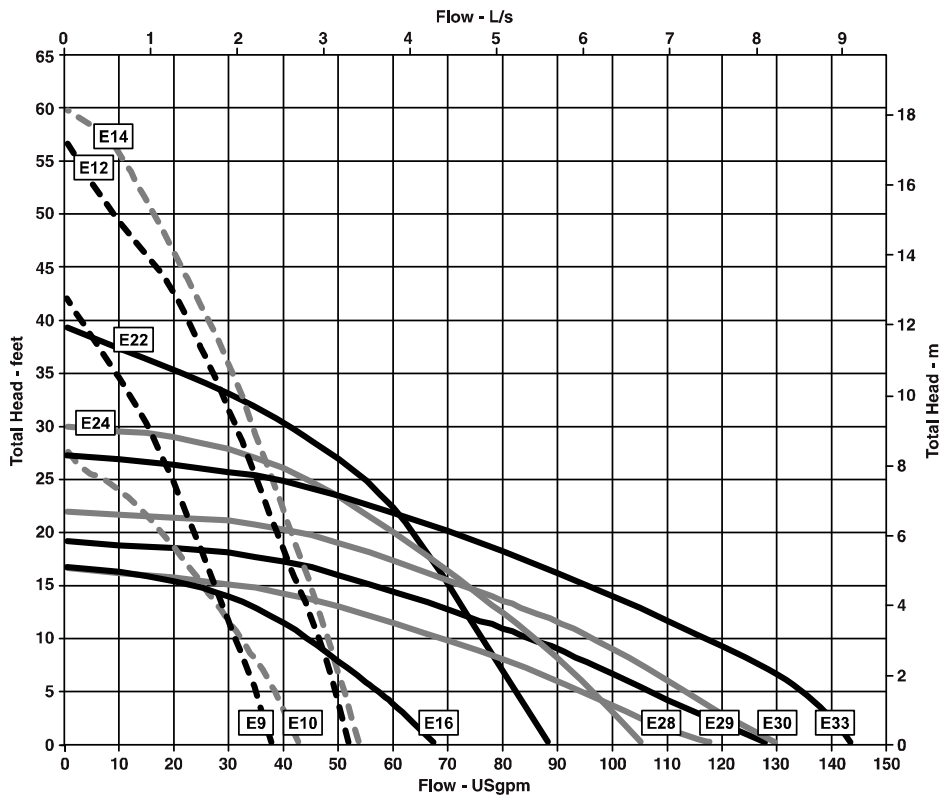
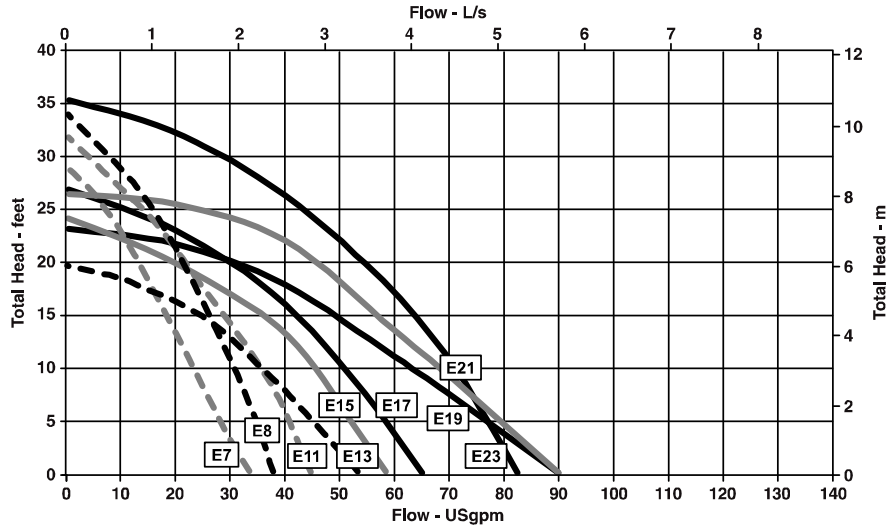

S. A. Armstrong Limited
 23 Bertrand Avenue
 Toronto, Ontario
 Canada, M1L 2P3
 T: 416-755-2291
 F: 416-759-9101

Armstrong Pumps Inc.
 93 East Avenue
 North Tonawanda, New York
 U.S.A. 14120-6594
 T: 716-693-8813
 F: 716-693-8970

Armstrong Integrated Limited
 Wenlock Way
 Manchester
 United Kingdom, M12 5JL
 T: +44 (0) 8444 145 145
 F: +44 (0) 8444 145 146



© S.A. Armstrong Limited 2011