



## DESIGN ENVELOPE®

### Intelligent Pumps

with cloud-based  
Active Performance  
Management®

All Design Envelope pumps  
substantially exceed USA/Canada  
pump energy index regulations



#### SOLUTION OUTLINE



# DESIGN ENVELOPE

## ENGINEERED BEYOND THE OBVIOUS

Design Envelope technology is a demand-based, intelligent control solution that:

Models equipment and system behaviour

Senses actual system conditions

Dynamically adjusts equipment operation to match system demand



Whether driven by social, environmental or fiscal responsibility, forward-thinking organizations must embrace energy-saving technologies and practices on their path to Net Zero.

**A**rmstrong Design Envelope pumps are a complete solution for heating, cooling and plumbing systems. The integration of a perfectly matched hydraulics, motive power and intelligent control creates the highest value pumping solution.

# MAXIMUM ENERGY AND COST SAVINGS

- 1 Technology benefits
- 2 How it works
- 3 The solutions
- 4 Armstrong services
- 5 Solution range

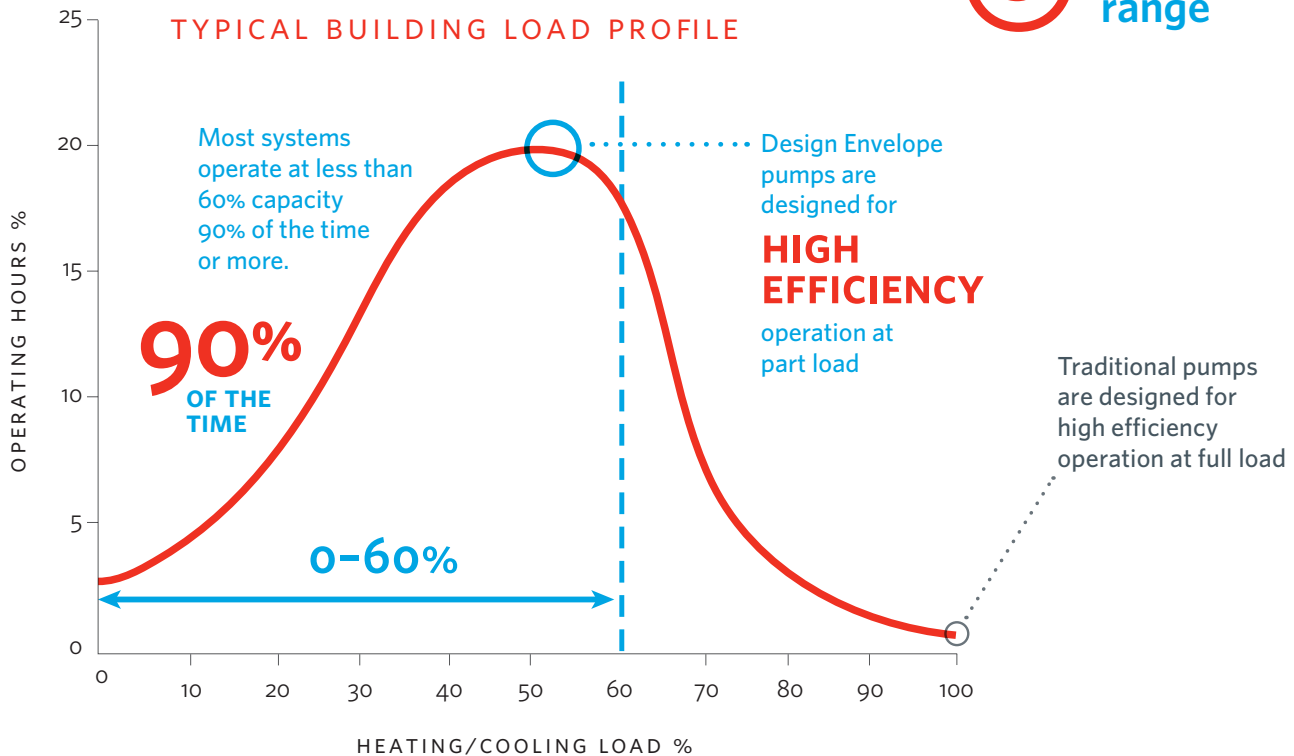

## Sizing and selecting for lowest energy consumption

Design Envelope solutions reduce pumping costs through demand-based operation — consuming only the energy required, based on current system demand. Design Envelope pumps use a combination of optimized impeller size, speed control and Active Performance Management for lowest energy use within a given performance envelope. The performance envelopes are selected for

lowest energy consumption where variable flow systems operate most often. This ensures a building's pumping system consumes as little energy as possible. It also helps to ensure that the installation meets or exceeds ASHRAE 90.1 guidelines requiring 70% energy savings at 50% of peak load.

\*Compared to a fixed speed system

# 1

## TECHNOLOGY BENEFITS

### FLOW INFORMS

**T**he rate of fluid flow in an HVAC system is crucial to understanding how the different components are operating. Without information on system flow, it's difficult to diagnose and optimize performance. With accurate flow information, the picture changes entirely. Armstrong can optimize each component and the overall system.

Design Envelope Pumps monitor flow so accurately they function as a flow meter. Industry standards recommend balancing system flows to  $\pm 5\%$  accuracy. Design Envelope pumps deliver accuracy of  $\pm 5\%$ .

**Highly accurate and reliable:** no issues with fouling, so no need to service or re-calibrate.

**Low installation cost:** easy installation for retrofits.

**Integral to pump:** no additional space or wiring required.

**Energy savings:** accurate flow data informs optimization of an entire HVAC system.

For evaluating an HVAC system, just two flow values and four temperature points provides all the data needed to understand flow rates, heat loads and operating efficiency.

**$\pm 5\%$**

**FLOW MEASUREMENT ACCURACY**

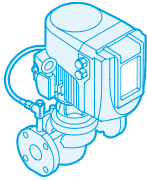
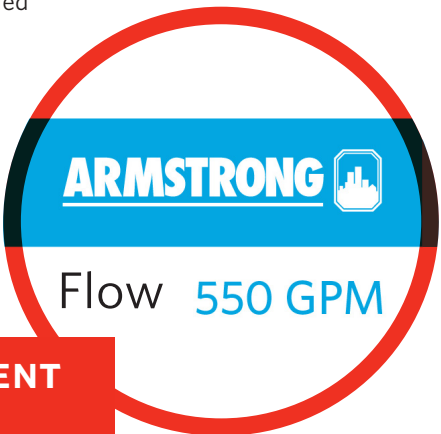

**PUMPING SYSTEMS**

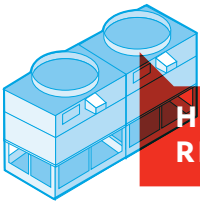
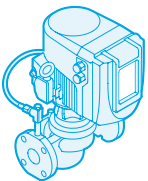

**HEAT REJECTION**

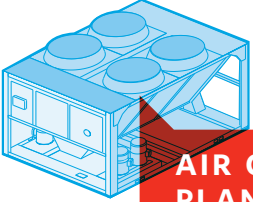
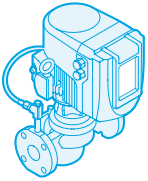

**AIR COOLED PLANT**

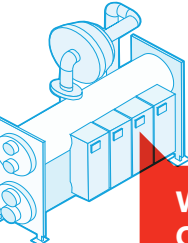
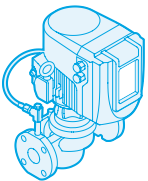

**WATER COOLED PLANT**





# ACTIVE PERFORMANCE MANAGEMENT™

Active Performance Management is a systems management approach that optimizes HVAC systems at any stage of a building's life-cycle by continually learning from a broad network of installations and responding to changing HVAC requirements.

The combination of smart commissioning with real-time alerts and system transparency addresses performance drift and maintains occupant comfort.

Bring performance drift under control

With Active Performance Management at the plant level, you can save up to

**40%** Annual cost savings

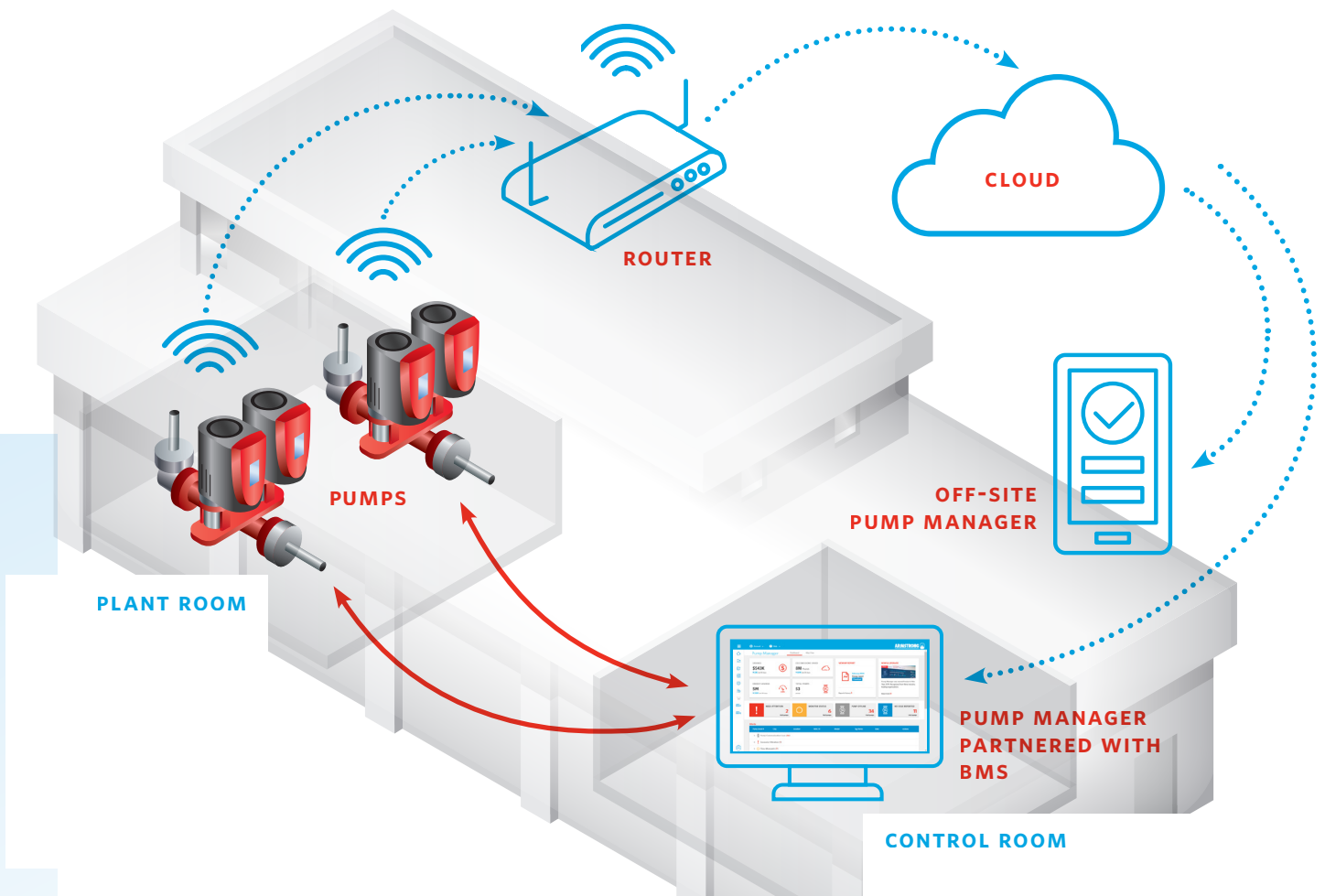

# THE RESULTS

ENERGY SAVINGS UP TO

90%+



**LOWEST ENERGY USE**

1

Armstrong Design Envelope Pumps provide you with highest energy efficiency.



**LOWEST INSTALLED COST**

2

Design Envelope Pumps provide lowest installed equipment cost, plus savings in infrastructure such as transformers, switch gear, power cables, concrete and cabling.



**LOWEST OPERATING COST**

3

Design Envelope Pumps provide lowest operating and maintenance cost.

## CASE STUDY | National Grid

ANNUAL ENERGY SAVINGS



70%

Armstrong recently completed a project in the United Kingdom, retrofitting pumps in a commercial office building belonging to National Grid. The retrofit included new pump sets that reduced energy consumption by 70%, saving over £22,400 annually.

### ANNUAL ENERGY COST

BEFORE	AFTER
32,152	9,752
£ UK	£ UK
AVERAGE	AVERAGE

ANNUAL COST SAVINGS **£22,400** UK

### CO<sub>2</sub> EMISSIONS

BEFORE	AFTER
82,309	24,967
kg CO <sub>2</sub>	kg CO <sub>2</sub>
AVERAGE	AVERAGE

ANNUAL CO<sub>2</sub> EMISSION REDUCTION **57,342** kg CO<sub>2</sub>



**FACILITY TYPE**  
Commerical office



**LOCATION**  
Solihull, Birmingham



**SIZE**  
Three-storey building



4

Design Envelope Pumps provide buildings with the lowest operational and embodied carbon.



5

Design Envelope Pumps provide lowest project and operating risk, with solutions adaptable to design and building changes. It's even adaptable for future legislation.



Together, these five key benefits of Design Envelope technology provide customer value far beyond alternative variable-speed or constant-speed solutions.

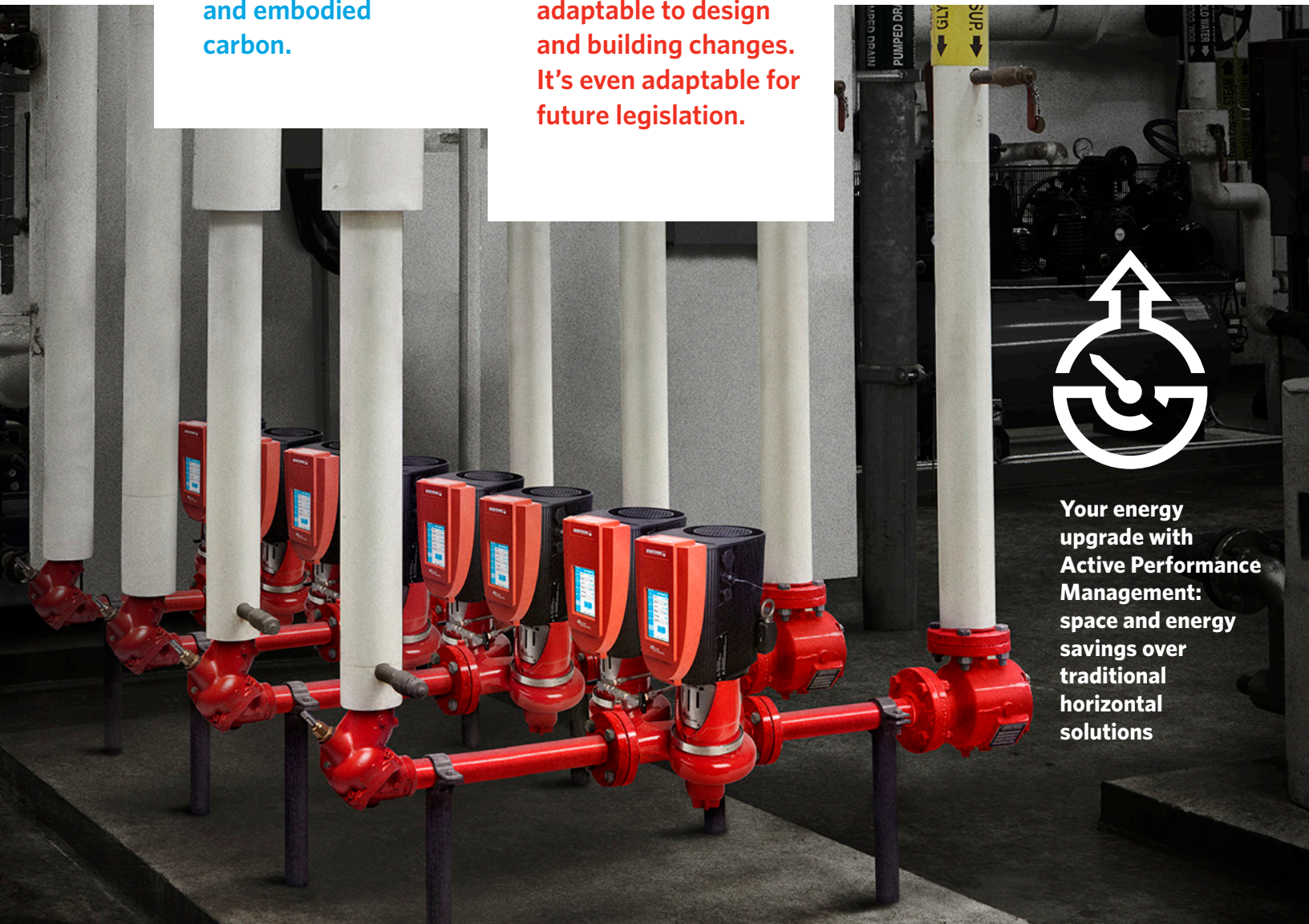

Your energy upgrade with Active Performance Management: space and energy savings over traditional horizontal solutions

# 2

## HOW IT WORKS

### SENSORLESS TECHNOLOGY

# THE SENSOR WITHIN

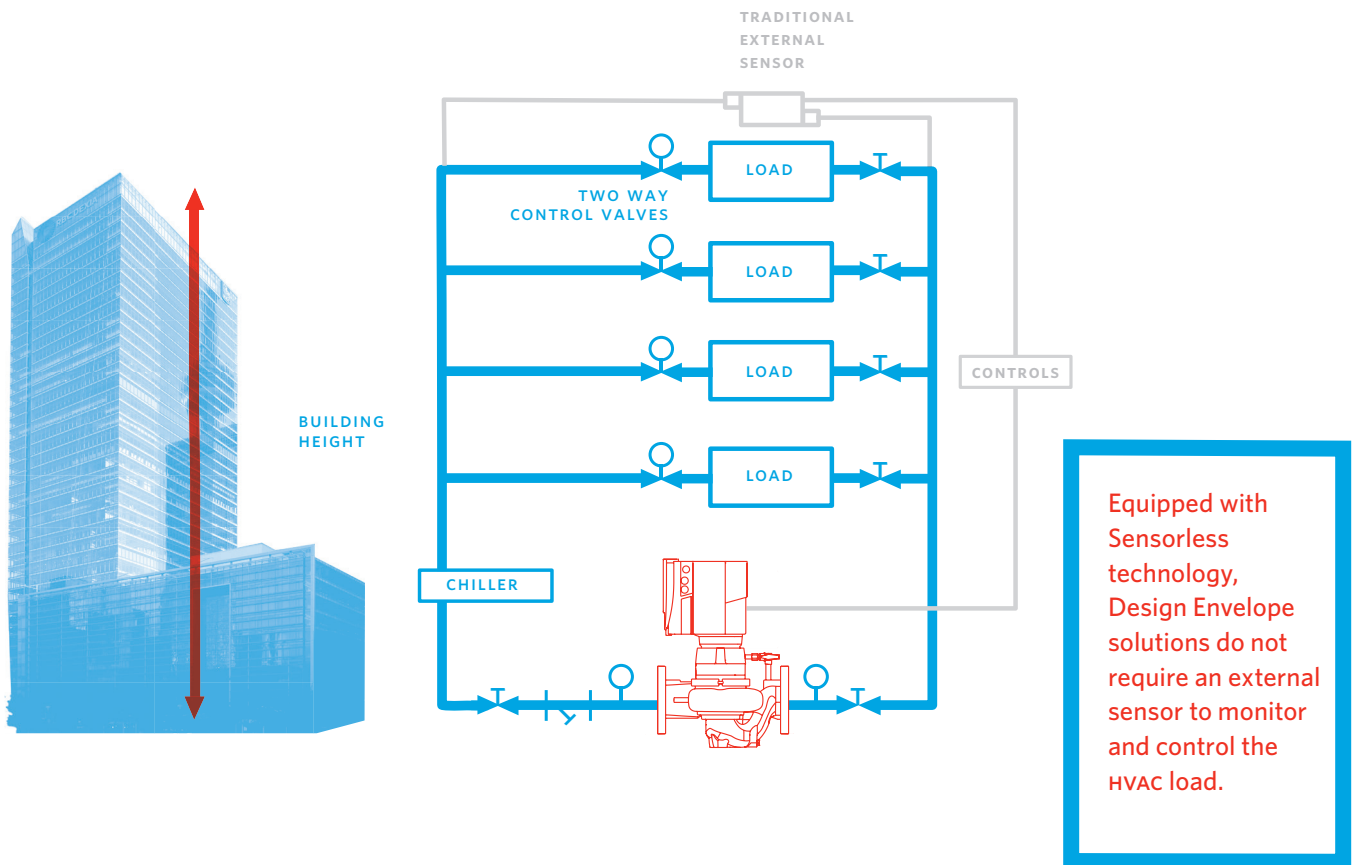

Using Sensorless technology, a Design Envelope pump's performance data (power draw and RPM) and operating curve are pre-programmed into the controller. During operation, the controller monitors the power draw and RPM of the pump and establishes the hydraulic performance and position of the pump's head-flow condition relative to the system requirements.

As the building's control valves open or close to regulate flow to the cooling coils and maintain building occupant comfort, the Sensorless controller automatically adjusts to match the required system pressure and flow.



# MONITOR POWER & SPEED

# CONTROL HEAD & FLOW

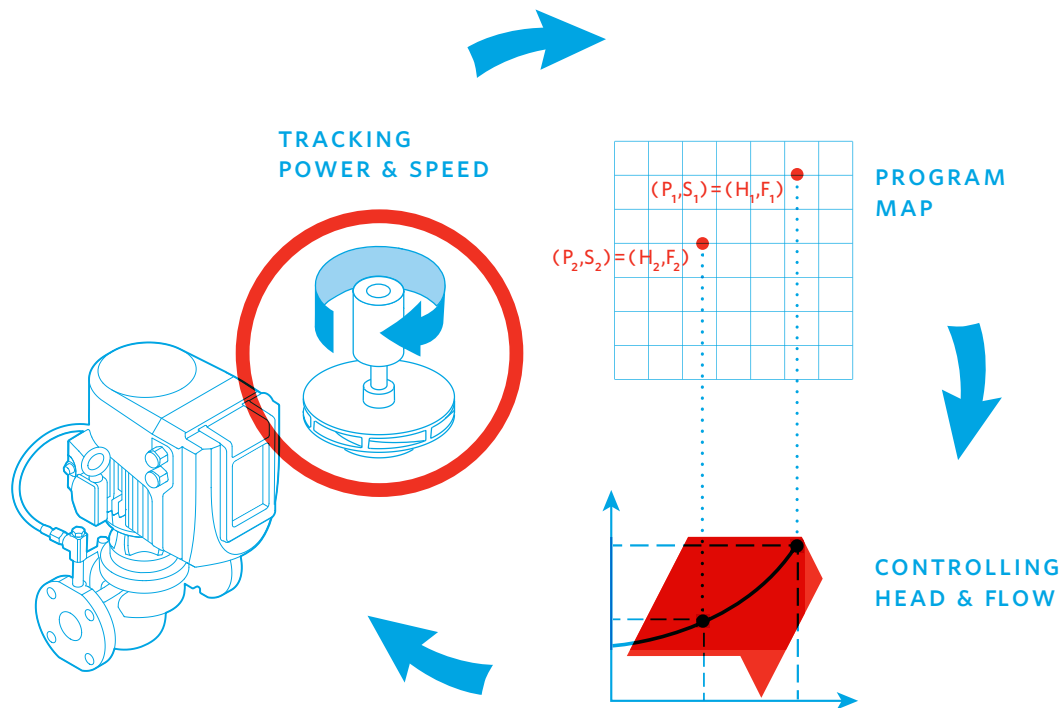

**Equipped with Sensorless technology, Design Envelope solutions do not require an external sensor to monitor and control the HVAC load.**

In a chilled water system, a building's temperature controls influence the local flow of control valves that modulate the flow to the cooling coils (load). As the control valves open for more chilled water flow, the differential pressure across the valve decreases.

The controller reacts to this change by increasing the pump speed. If the control valves close to reduce the chilled water flow, the differential pressure across the valve increases and the controller reduces the pump output.

# PARALLEL SENSORLESS

SAVE UP TO **30%**

ON OPERATING COSTS

**P**arallel Sensorless Pump Control (PSPC) is a patented technology that lowers the energy consumption of a multi-pump installation through optimized load sharing.

The traditional approach to control in a multi-pump installation involves staging pumps on the basis of motor speed. Parallel Sensorless Pump Control technology stages pumps based on operating efficiency rather than motor speed and lowers the energy consumption of the full pump array by up to 30% over traditional multi-pump installations.

HVAC loads and flow requirements change throughout the day. In the graphs to the right, the grey dotted line intersecting the pump efficiency curves represents the flow level at which one pump in the array should be staged on or off. The solid grey line, however, indicates where staging often occurs with speed-based control, which forces the pump array to operate at efficiency levels that are less than optimal.

In an installation of (up to four pumps) Parallel Sensorless Pump Control controls pump speed and stages pumps at the correct flow levels to optimize efficiency, as shown in the bottom-right graph.

## TRADITIONAL SPEED-BASED STAGING

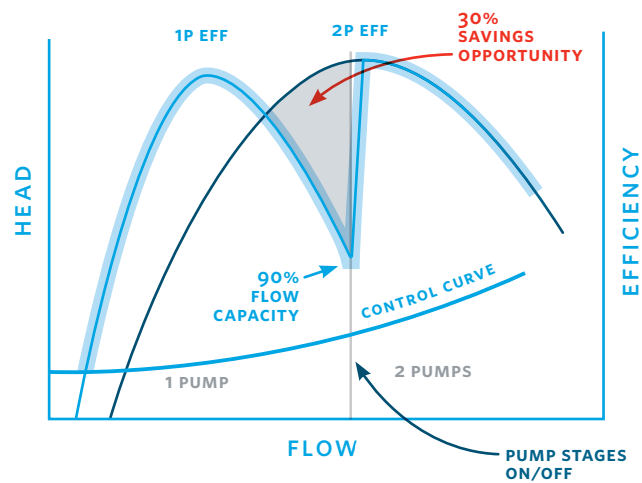

## PARALLEL SENSORLESS PUMP CONTROL BEST-EFFICIENCY STAGING

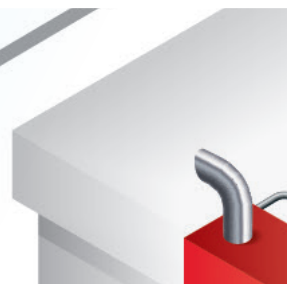
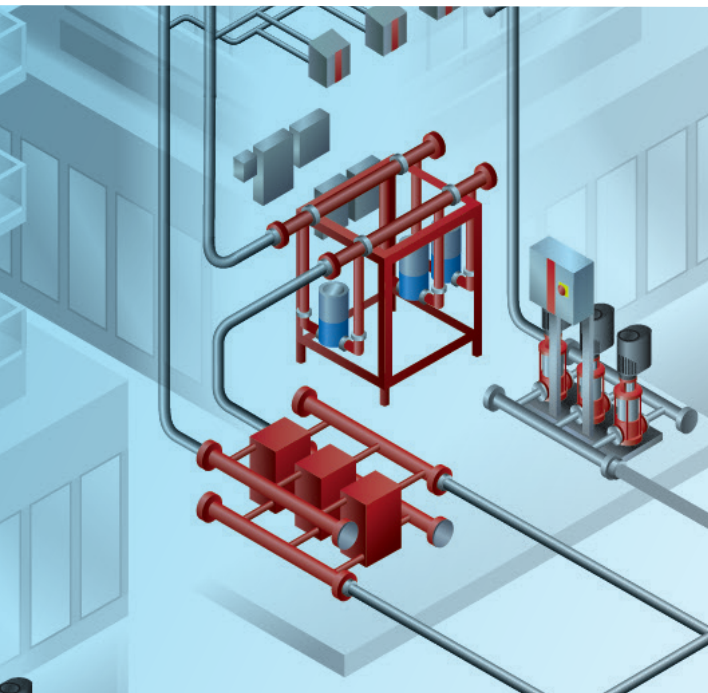
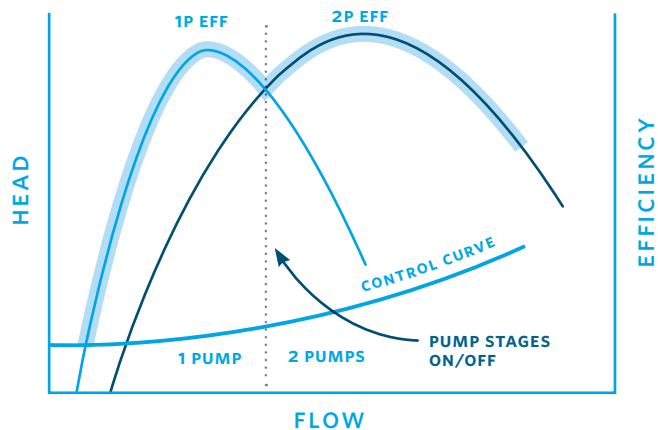

Because HVAC pumping systems mostly operate at part-load, a design using two or more smaller pumps is more efficient than one larger pump. In a two-pump system, if one pump fails, the remaining pump can serve the system

requirements with up to 70% flow redundancy. The capacity split can be adjusted based on the building type and duty requirement.

## REDUNDANCY AND SAVINGS WITH PARALLEL PUMPING

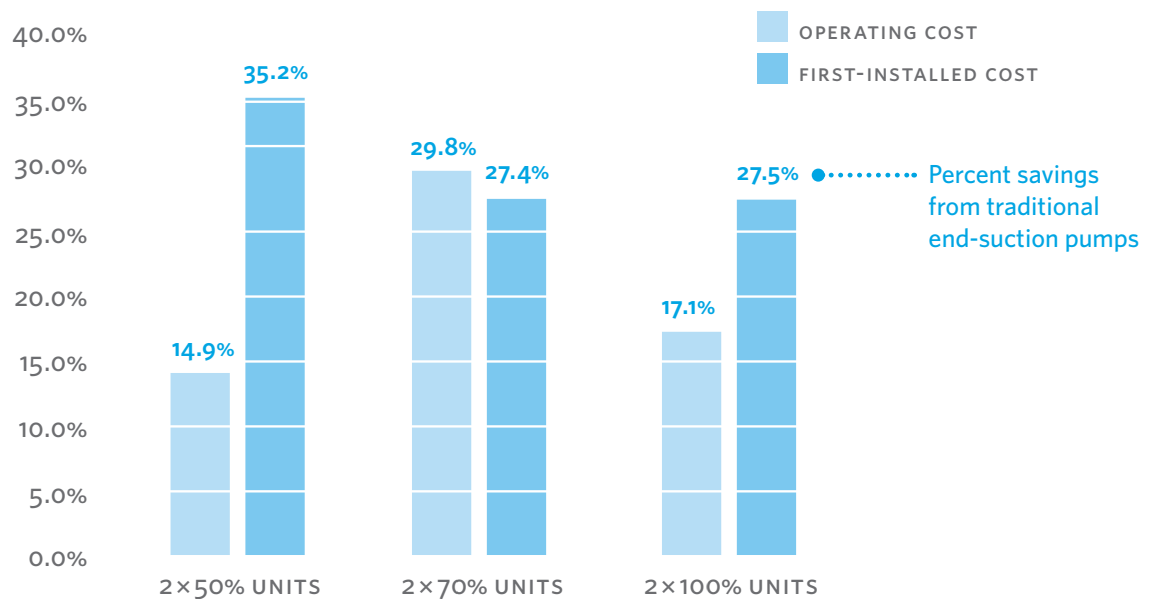

CAPACITY SPLIT	FLOW REDUNDANCY	DUTY REQUIREMENT	TYPICAL BUILDING EXAMPLES
Two pumps running at <b>50%</b>	If one pump fails, the other will operate at <b>70%</b>	Generic duty	Schools Apartments Condos
Two pumps running at <b>70%</b>	If one pump fails, the other will operate at <b>85%</b>	High comfort sensitivity	Hotels Offices Outpatient clinics
Two pumps running at <b>100%</b>	If one pump fails, the other will operate at <b>100%</b>	Mission critical	Blood banks Hospitals Data centers

# 3

## THE SOLUTIONS

# TANGO

DESIGN ENVELOPE | TECHNOLOGY

Advanced hydraulic design supports industry-leading flow efficiency

Built-in Parallel Sensorless pump control saves up to 30% more energy

Armstrong DEPM motor technology delivers an additional 6-20% efficiency, meeting IE5 efficiency standards

Control algorithm constantly reviews operating conditions and adjusts output to meet immediate flow requirements at minimum energy consumption

15 minutes to replace the mechanical seal with no need for realignment, saving up to \$700



Available for outdoor operation

## THE NEED FOR AVAILABILITY

Most building HVAC systems operate at the design point (100% load) less than 1% of the time. Traditional system design applies 100% redundancy and duplication of components to ensure that the design point can always be met. This creates huge over-capacity and higher costs.

The traditional duty/standby approach to redundancy in HVAC systems inflates the installed costs for equipment and labor, and adds to the carbon footprint of the building. Tango's dual-pumping configuration modernizes the approach to redundancy. Pumps and motors are selected from a range of sizes to achieve a level of redundancy that matches the requirements of the application.

With the proper approach to redundancy, HVAC requirements can be met for all but the most extreme days of the year; and for those few days, variation in temperature will be minimal.

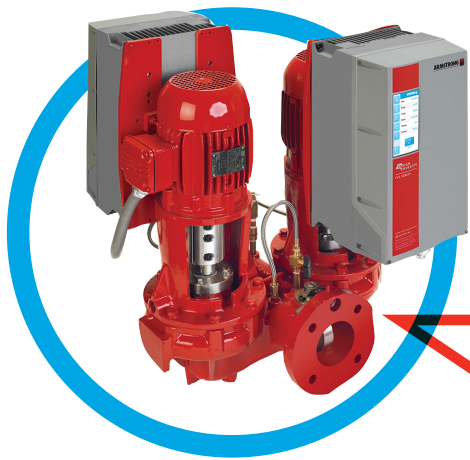

**Dual-Arm Pumps**  
For pumps larger than 10hp/7.5kW use dualArm pumps for lowest installed cost, lowest life cycle operating cost achieved with Parallel Sensorless, and increased serviceability with built-in isolation valves

# FOR ALL DESIGN ENVELOPE SOLUTIONS

## Advanced performance control

Armstrong has reinvented and redesigned pumping solutions to include connectivity and performance management services. Design Envelope Pumps provide optimal lifetime efficiency through:

Expanded performance range (and options)

One-touch auto-flow balancing

Pump control based on an adjustable quadratic control curve for better part-load efficiency

Flow accuracy (+/- 5%)

Operating data and notifications to support diagnostics and service

Advanced onboard control functions

## PERFORMANCE PACKAGES

## FUNCTIONS INCLUDED



**Sensorless Bundle (standard)**

- Sensorless control
- Flow meter
- Constant flow
- Constant pressure



**Parallel Sensorless (standard on Tango and dualArm)**

- Parallel Sensorless control



**Energy Performance Bundle**

- Auto-flow balancing
- Maximum flow control



**Protection Bundle**

- Minimum flow control
- Bypass valve control



**Zone optimization**

- Accept up to two dP sensor control signals



**Dual-season setup**

- Pre-set heating and cooling parameters for two-pipe systems

## CASE STUDY | Delta Hotel

ANNUAL ENERGY SAVINGS



40%



The Delta Hotel commissioned an upgrade of one of their 10-year-old Design Envelope pump to a new Tango. New control algorithms and performance management of the Tango pump proved that the upgrade was the right choice. The total annual energy cost savings amounted to over \$2,295 with a total kWh savings of 22,957 kWh: a 40% savings overall.



**FACILITY TYPE**  
Hotel



**LOCATION**  
Toronto, Canada



**SIZE**  
300,000 ft<sup>2</sup>

### ANNUAL ENERGY COST

BEFORE

AFTER

5,659

3,364

\$ CAD

\$ CAD

AVERAGE

AVERAGE

ANNUAL COST SAVINGS

\$2,295 CAD

### CO<sub>2</sub> EMISSIONS

BEFORE

AFTER

7,923

4,709

kg CO<sub>2</sub>

kg CO<sub>2</sub>

AVERAGE

AVERAGE

ANNUAL CO<sub>2</sub> EMISSION REDUCTION

3,214 kg CO<sub>2</sub>

# VERTICAL IN-LINE

# PUMPS (VIL)

DESIGN  
ENVELOPE

TECHNOLOGY



For a 10 hp/7.5 kW pump, save \$2,000 with pipe mounting and no inertia base

## Mechanical room space savings

Pumps require minimal floor space or can be installed overhead

## Reduced vibration

Optimally-designed, dynamically-balanced impeller and shaft assembly operates with minimum vibration

## Lowest installed cost and embodied carbon

Component, Material and Labor savings: fewer fittings and no housekeeping pad required

## Reliability

Vertical In-Line design requires less maintenance, at a lower cost, than any other pump configuration

## Easy maintenance

15 minutes to replace the mechanical seal: no need for realignment; saves up to \$700



## DEPM Single-Phase Pumps

Available in 1-phase 200-230V up to 2hp

# NEW DEPM IVS



AVAILABLE IN SELECT  
SIZES UP TO 60HP

35-65% lower operating costs over  
conventional integrated pumps

Smaller motor and controls size  
on 40% of hydraulic selections for  
lower pump and infrastructure costs

Simplified handling with single point lifting

Meets Ultra Premium (IE5)  
Efficiency motor levels

50% weight reduction and  
50% embodied carbon  
reduction

Available  
for outdoor  
operation



## CASE STUDY | Carlson Court

ANNUAL  
ENERGY  
SAVINGS



87%

Armstrong replaced six constant speed pumps with new Vertical In-Line pumps. Combining Design Envelope technology and Pump Manager, Armstrong optimized pump operations for annual energy savings of 87%.

### ANNUAL ENERGY COST

BEFORE	AFTER
\$140,072 CAD	\$18,380 CAD
AVERAGE	AVERAGE



ANNUAL  
COST  
SAVINGS **\$121,692** CAD

### CO<sub>2</sub> EMISSIONS

BEFORE	AFTER
150,847 kg CO <sub>2</sub>	19,794 kg CO <sub>2</sub>
AVERAGE	AVERAGE



ANNUAL CO<sub>2</sub>  
EMISSION  
REDUCTION **131,053** kg CO<sub>2</sub>



FACILITY TYPE  
Large Office  
Complex



LOCATION  
Toronto,  
Canada



SIZE  
300,000 ft<sup>2</sup>



# END SUCTION

DESIGN  
ENVELOPE

TECHNOLOGY

**NO INERTIA BASE NEEDED\***  
**= SAVINGS OF**  
**\$2,000** \*10hp / 7.5kW or smaller



HVAC pumping systems are expected to operate smoothly and quietly.

Although it's practical to mount pumps on the floor, this practice can also transmit noise or vibration to the rest of the building. Concrete and inertia bases have traditionally been used to mitigate vibration, but this adds excess weight and cost to the installation.

The new Design Envelope End Suction pump with integrated vibration isolation:

**Eliminates the need for inertia bases\***

**Reduces installed costs and operating cost**

**Adds more value than any other horizontal pump**

## EQUIPMENT AND MATERIAL SAVINGS

**No inertia base, concrete and curing time required**

**Rigid pump design needs no steel baseplate**

**No differential pressure sensors required**

**Less concrete means a lower carbon footprint**

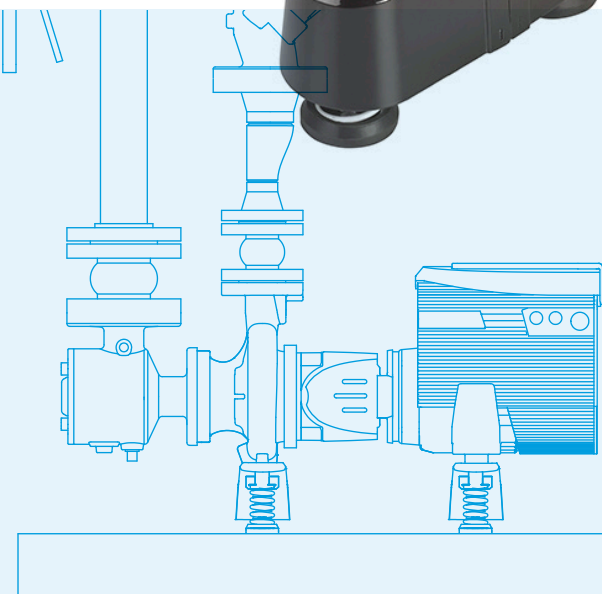



Integral vibration isolation eliminates the need for inertia bases or baseplates. The following features minimize the transmission of vibration:

Balanced rotor design

Soft start controls

Direct coupling to motor

Reduced overall weight

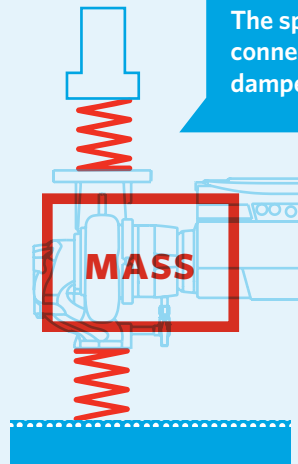

With flex connectors separating the pump from the piping, and vibration isolators between the pump and the ground, the pump floats in an isolated spring system.

The ASHRAE handbook recommends the use of inertia bases even for pump installations on grade

In pumps over 10 hp the integrated design with baseplate has a lower installed cost than a traditional pump with a wall-mounted drive

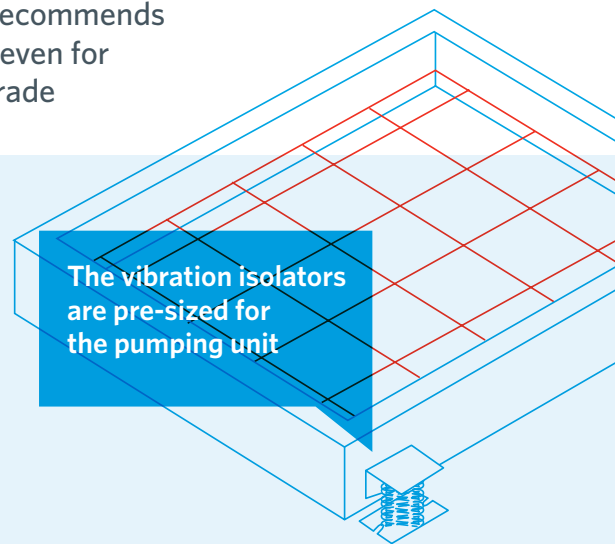

## CASE STUDY | Texas Christian University

ANNUAL ENERGY SAVINGS



63%



In 2018 Armstrong upgraded three constant-speed pumps in the Recreation Center. As a result of the retrofit project, TCU is saving over \$7,500 per year.

### ANNUAL ENERGY COST

BEFORE	AFTER
\$12,106 USD	\$4,525 USD
AVERAGE	AVERAGE



ANNUAL COST SAVINGS **\$7,581** USD

### CO<sub>2</sub> EMISSIONS

BEFORE	AFTER
80,792 kg CO <sub>2</sub>	30,193 kg CO <sub>2</sub>
AVERAGE	AVERAGE



ANNUAL CO<sub>2</sub> EMISSION REDUCTION **30,193** kg CO<sub>2</sub>



FACILITY TYPE  
Recreation Centre



LOCATION  
Fort Worth, Texas



SIZE  
179,831 ft<sup>2</sup>



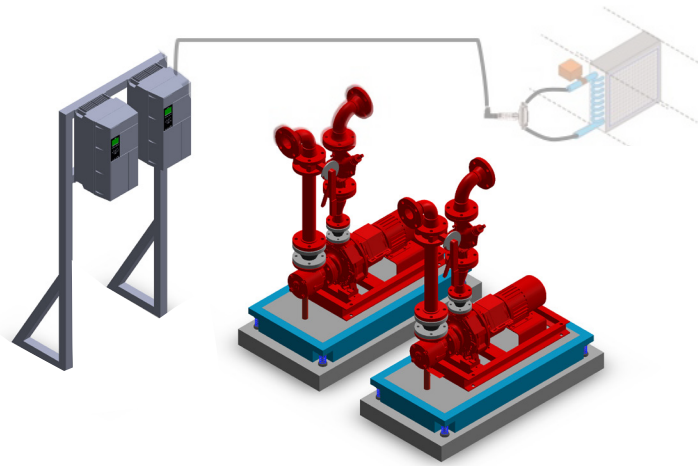

# CHOOSE YOUR CONFIGURATION

## INSTALLATION COST COMPARISON



Armstrong is a leader in Embodied Carbon Reduction in our products.

- Less material weight results in less embodied carbon in the product
- Elimination of inertia bases results in less embodied carbon in the construction/ installation stage

	2 × End Suction with drive on wall and remote pressure sensor 100% duty/standby	1 Tango pump with sensorless and parallel sensorless control 2 × 50% capacity split, parallel operation
 Total pump weight	682 lbs	91 lbs <b>87% savings</b>
 Installation weight	2,221 lbs	521 lbs <b>76% savings</b>
 Installation footprint	26.6 sf	5.8 sf <b>78% savings</b>
 Installation cost	\$9,004	\$1,829 <b>80% savings</b>
	<ul style="list-style-type: none"> <li>▪ Legacy design</li> <li>▪ Base case for comparison</li> <li>▪ Time-intensive seal change</li> </ul>	<ul style="list-style-type: none"> <li>▪ Managed redundancy and parallel operation replaces duty/standby</li> <li>▪ Smaller units are easier to handle</li> <li>▪ Two rotating devices sharing one casing</li> <li>▪ Reporting and proactive management</li> <li>▪ Optimized lifetime performance</li> </ul>

Complete integrated solutions offer the lowest installed cost and add value in lifetime energy and maintenance savings

## DESIGN ENVELOPE CONFIGURATION OPTIONS

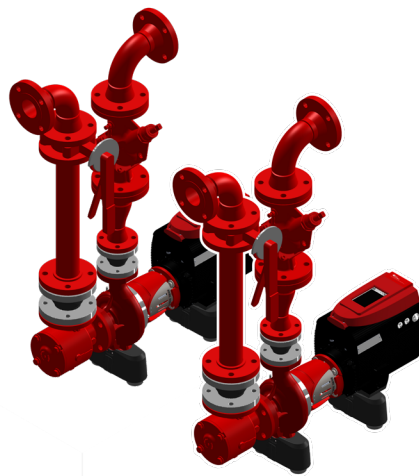
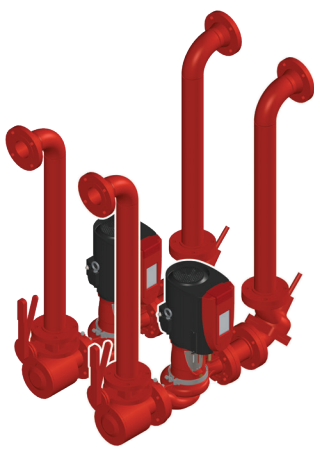

2 × Design Envelope Vertical Inline with sensorless control 100% duty/standby*	2 × Design Envelope End Suction with sensorless control 100% duty/standby*
216 lbs 68% savings	198 lbs 71% savings
748 lbs 66% savings	961 lbs 57% savings
12.3 sf 54% savings	18.1 sf 32% savings
\$4,163 54% savings	\$4,906 46% savings
<p>Eliminates the need for: housekeeping pads, inertia base, flex connections, grouting and alignment</p> <ul style="list-style-type: none"> <li>▪ Reduced installation labor costs</li> <li>▪ Smaller mechanical room footprint (50-75%)</li> </ul>	<p>Eliminates the need for: housekeeping pads, inertia base, flex connections, grouting and alignment</p> <ul style="list-style-type: none"> <li>▪ Reduced installation labor costs</li> <li>▪ Smaller mechanical room footprint (50-75%)</li> </ul>

\*May also be sized  
2 × 50% parallel

# 4

## ARMSTRONG SERVICES & PARTS

**A**rmstrong's 360 Service and Support provides complete solution support for engineers, contractors and owners. Working with our network partners, we provide support to help you get the best possible performance from fluid-flow systems.

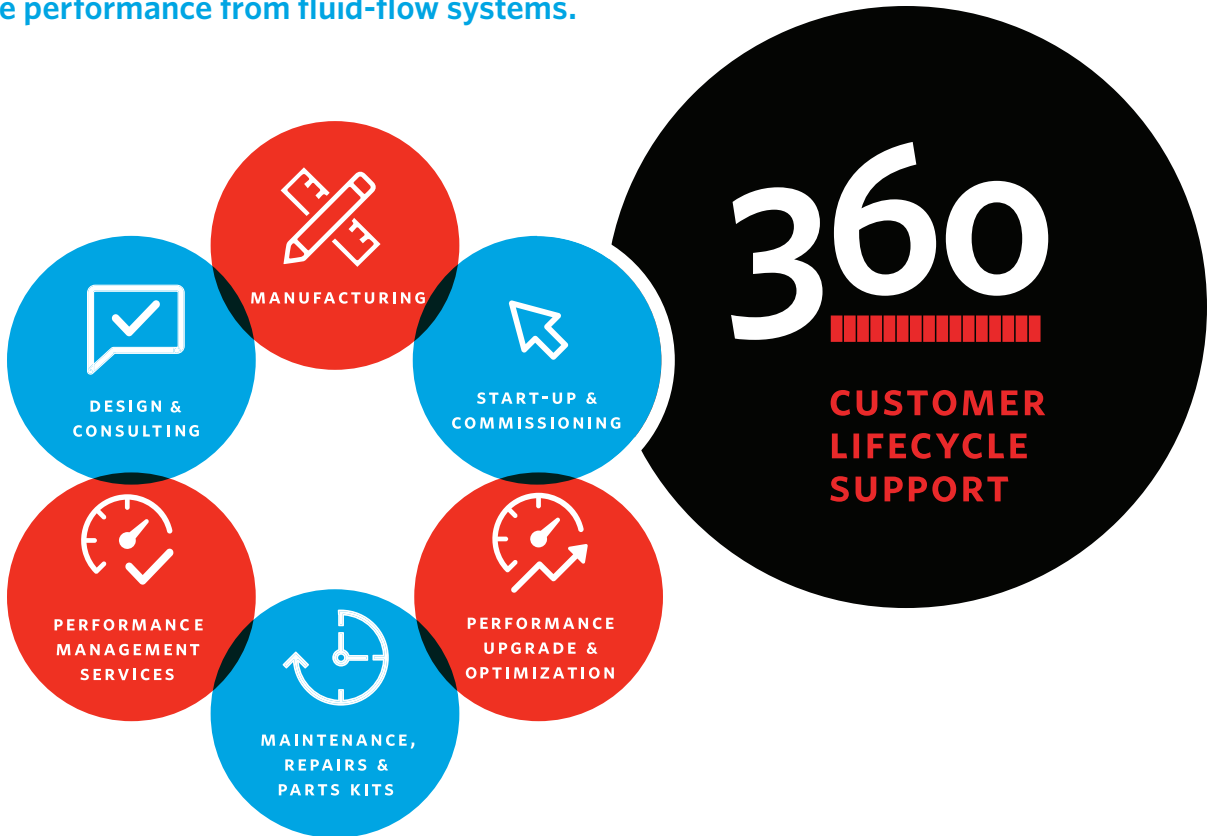

Rapid response attention

**MATCHED TO  
YOUR NEEDS.**

**+ 24/7 GLOBAL  
RAPID RESPONSE**



# ARMSTRONG PARTS KITS: ENGINEERED AND PRE-ASSEMBLED

**A**rmstrong Parts Kits are engineered combinations of genuine replacement parts — planned, selected and packaged based on solution types and sizes. Use Parts Kits for maintenance projects to add value to your building operators and service personnel.



## CASE STUDY | Commercial Towers

**T**he owners of this pair of commercial towers recently completed an HVAC upgrade, replacing three constant speed pumps with new Design Envelope pumps with Pump Manager.

Along with the energy savings, Pump Manager provided system warnings that helped avoid expensive repairs and energy losses.



**FACILITY TYPE**  
Commercial office tower



**LOCATION**  
Toronto, Ontario



**SIZE**  
18 floors,  
20,000 ft<sup>2</sup>  
per floor



**ANNUAL ENERGY SAVINGS**

**77%**



**ANNUAL ENERGY COST**

BEFORE	AFTER
\$68,185	\$15,918
CAD	CAD
AVERAGE	AVERAGE

**ANNUAL COST SAVINGS**  
**\$52,267<sup>CAD</sup>**

**SOLUTION EMPLOYED**

**DESIGN ENVELOPE**

**VERTICAL IN-LINE PUMP**



# 5

## DESIGN ENVELOPE PUMP RANGE

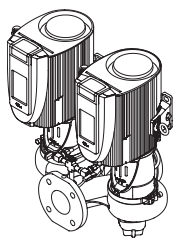
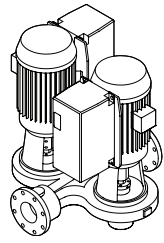
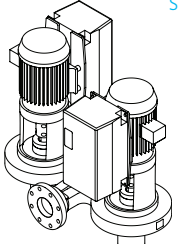
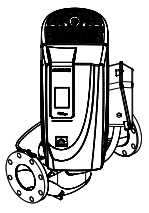
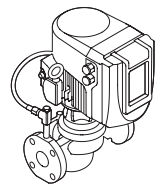
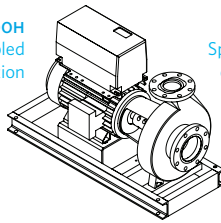
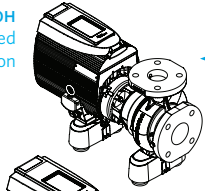
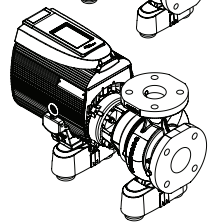
	INDOOR	OUTDOOR
 <p>4322/4372 Split and close-coupled Tango</p>	0.33-10 hp	0.33-10 hp
 <p>4302 Split-coupled dualArm</p>	15-100 hp	15-100 hp
 <p>4312 Split-coupled Twin</p>	15-40 hp	1-40 hp
 <p>4300 Split-coupled vertical in-line</p>	0.33 - 450 hp 450 - 1250 hp with Standalone control	0.33 - 125 hp N/A
 <p>4380 Close-coupled vertical in-line</p>	0.33 - 10 hp 1 - 2 hp in Stainless steel	0.33 - 10 hp N/A
 <p>4200H Split-coupled end suction</p>	1-10 hp with integrated vibration isolators	N/A
 <p>4200H Split-coupled end suction</p>	15-125 hp	N/A
 <p>4280 Close-coupled end suction</p>	1-10 hp with integrated vibration isolators	N/A

**PUMP MODELS  
DESIGNED AND  
ENGINEERED  
FOR OUTDOOR  
OPERATION**

Controls enclosure rated for UL Type 4X  
 Equipped with overhead weather shield to prevent pump from icing in cold weather conditions and overheating when exposed to direct sunlight



# OUR SERVICE TO THE PLANET



## PLANET PROPOSITION

**T**hrough our Planet Proposition charter, Armstrong has committed to minimizing our impact on the environment. Around the world, Armstrong's Planet Proposition teams have taken on projects that are helping us meet our targets. Two examples of successful projects are:

### NET ZERO CARBON BUILDINGS COMMITMENT

The Net Zero Commitment positions energy efficiency as a central component to achieving decarbonization globally. In signing the Net Zero Carbon Buildings Commitment, Armstrong has pledged to ensure our entire portfolio of buildings operates at net zero carbon by the year 2030.



WATCH THE VIDEO



See how we achieved a key target in reducing greenhouse gas emissions by 2 millions tons



**TORONTO**

23 BERTRAND AVENUE,  
TORONTO, ONTARIO,  
CANADA, M1L 2P3  
+1 416 755 2291

**BUFFALO**

93 EAST AVENUE, NORTH  
TONAWANDA, NEW YORK,  
USA, 14120-6594  
+1 716 693 8813

**DROITWICH SPA**

POINTON WAY, STONEBRIDGE CROSS  
BUSINESS PARK, DROITWICH SPA,  
WORCESTERSHIRE,  
UNITED KINGDOM, WR9 0LW  
+44 121 550 5333

**MANCHESTER**

WOLVERTON STREET, MANCHESTER  
UNITED KINGDOM, M11 2ET  
+44 161 223 2223

**BANGALORE**

#18, LEWIS WORKSPACE, 3<sup>RD</sup> FLOOR,  
OFF MILLERS - NANDIDURGA ROAD,  
JAYAMAHAL CBD, BENSON TOWN,  
BANGALORE, INDIA 560 046  
+91 80 4906 3555

**SHANGHAI**

UNIT 903, 888 NORTH SICHUAN RD.  
HONGKOU DISTRICT, SHANGHAI  
CHINA, 200085  
+86 21 5237 0909

**BEIJING**

ROOM 1612, NANYIN BUILDING NO.2  
NORTH EAST THRID RING ROAD  
CHAOYANG DISTRICT, BEIJING,  
CHINA 100027  
+86 21 5237 0909

**SÃO PAULO**

RUA JOSÉ SEMIÃO RODRIGUES  
AGOSTINHO, 1370 GALPÃO 6 EMBU  
DAS ARTES, SAO PAULO, BRAZIL  
+55 11 4785 1330

**LYON**

93 RUE DE LA VILLETTE  
LYON, 69003 FRANCE  
+33 4 26 83 78 74

**DUBAI**

JAFZA VIEW 19, OFFICE 402  
P.O. BOX 18226 JAFZA,  
DUBAI - UNITED ARAB EMIRATES  
+971 4 887 6775

**JIMBOLIA**

STR CALEA MOTILOR NR. 2C  
JIMBOLIA 305400, JUD.TIMIS  
ROMANIA  
+40 256 360 030

**FRANKFURT**

WESTERBACHSTRASSE 32,  
D-61476 KRONBERG IM TAUNUS  
GERMANY  
+49 6173 999 77 55

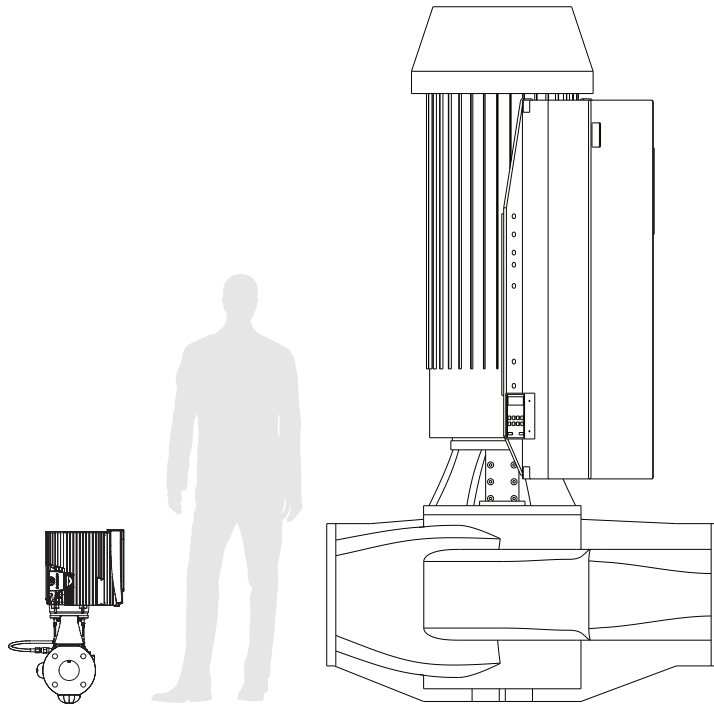

0.33 hp

1250 hp

**SELECT & CONFIGURE**

Use ADEPT Select to quickly and easily select  
Armstrong products that are right for your projects.  
Visit [adept.armstrongfluidtechnology.com](http://adept.armstrongfluidtechnology.com) to learn more.