

CIRCULATOR PUMP RANGE

HEATING

POTABLE WATER

SOLAR

GEOTHERMAL

CONDENSATE



ERP

2015⁺

BAFA

GEFÖRDERT



AN ARMSTRONG FLUID TECHNOLOGY BRAND
WWW.HALM-PUMPS.DE

ARMSTRONG FLUID TECHNOLOGY

Global leaders in high-efficiency, energy-saving innovations



Making Energy Make Sense

Armstrong Fluid Technology is known around the world as a forerunner and innovator in the design, engineering and manufacturing of intelligent fluid flow equipment. Serving customers in over 150 countries with expertise in fluid dynamics, heat transfer, variable speed, and demand-based control Armstrong Fluid Technology leads the fluid system industry, including HVAC, plumbing, and fire safety in providing the most energy-efficient and cost-effective solutions to building professionals and owners around the globe.

Day-to-day operations at Armstrong are founded on the core principles of community, service, learning and innovation. We are driven to preserve the environment and lead the global shift in responsible, sustainable energy use by developing innovative, high-value, energy-saving solutions.

Proudly featuring HALM, German-engineered, high-efficiency circulator pump range

For more than 30 years, HALM, based in Germany, developed, designed and produced pumps for residential and light commercial applications. In January 2018, Armstrong Fluid Technology acquired the Circulation Pumps business of HALM, offering advanced design and devotion to energy-efficiency and manufacturing quality under a united brand. With our operating directives founded on the core value of service, Armstrong is pleased to offer HALM German-engineered circulators to customers around the world.

Best-in-class

Under 7 product names Armstrong Fluid Technology offers Best-In-Class circulator solutions for Heating, Drinking Water, Solar, Geothermal, and Condensate applications. These solutions are excellent for use in both new installations and upgrading existing installation to meet higher performance requirements, especially in multi-family residential or commercial buildings.

For your convenience we are providing performance and technical details on these circulators in a catalogue format. Please contact your local Armstrong Representative with any questions you may have.

OPTIMO



OPTIMO (N)



OPTIMO L



BUPA



Contents	Page
GENERAL INFORMATION	4
Product range	
HEATING	
HEP Optimo Basic:	5
HEP Optimo:	8
HEP Optimo L:	11
HEP Optimo L+:	13
AGE3:	19
AGE3 D:	24
DRINKING WATER	
BUPA (N):	28
HEP Optimo Basic (N):	30
HEP Optimo (N):	33
BGPA (N):	36
AGE3 Z:	38
SOLAR	
HEP Optimo L Solar:	41
HEP BB2:	43
GEOHERMAL	
HEP Optimo Geo:	45
HEP Optimo L Geo:	48
CONDENSATE	
Lift:	50
Lift Basic:	51
Lift NT25:	52
ACCESSORIES/SPARE PARTS	
Screw connections	54
Flange adaptors for pipe installation (flange)	54
Insulation shell/Insulation shell for cold water applications	54
Plug	54
Accessories/Spare parts for condensate pumps	55

Subject to technical changes without notice. Errors and omissions excepted.

The latest versions of our sales, delivery, and payment conditions as well as guarantee terms can be found on the internet at www.halm-pumps.de

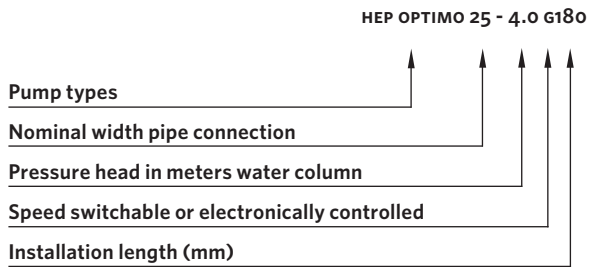
ARMSTRONG TYPE KEY (NOT AG3/AGE3)**INSTALLATION OPTIONS**

Circulation pumps must be installed with a horizontal shaft.

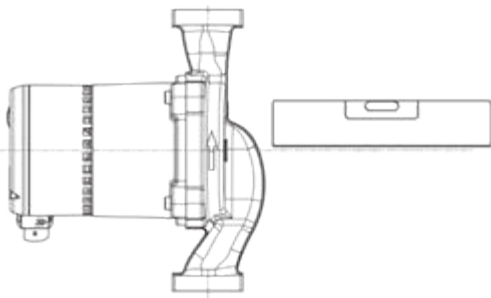
**CONSTRUCTION**

Armstrong circulation pumps are inline wet rotor circulators. They are maintenance-free and fitted with opposite-facing connecting nozzles of the same nominal width. The pump, motor and terminal box comprise one unit and are optimally matched with one another.

A stainless steel can separates the rotor chamber and stator winding. It features static seals at both ends.

BEARING

Both bearings are made of oxide ceramic. This is particularly suitable because of its hardness, surface quality and corrosion resistance. They ensure smooth running and a long service life. Air cavities in the can well are evacuated via the hollow shaft.

EEL REQUIREMENTS

Due to the European ErP Directive (Energy related Products) minimum requirements for energy consumption values of circulating pumps have been set since 2013. Circulation pumps which do not meet these minimum requirements may not be "marketed" by manufacturers or importers within the EU.

The energy efficiency index (EEI) is the basis for determining which pumps are to be used in the future. It is determined by a special calculation method and represents the ratio of the power consumption of a controlled "high efficiency" pump compared to an "unregulated standard" pump of the same hydraulic power. The EEI must be below a certain value.

Since August 1, 2015, a general minimum requirement of $EEI \leq 0.23$ applies.

In practice, this means that the electricity consumption of the high-efficiency pump with an EEI must be at least 0.77 (1 - 0.23), ie 77% below the current consumption of an old standard pump, according to the legal requirements of ≤ 0.23 . This value applies, of course, only if the high-efficiency pump is set to the "most energy-saving" proportional pressure mode with which such EEI requirements can only be fulfilled. However, even if plants are operated in the fixed-value mode without control, savings of approx. 50% are realistic due to the energy-saving ECM technology of high-efficiency pumps.

The original ErP requirements were tightened in 2015 in several respects:

- Since 1 August 2015, EEI is ≤ 0.23 instead of the original minimum requirement of ≤ 0.27 .
- Circulation pumps for solar thermal and heat pumps are no longer explicitly excluded.
- From 2020 onwards, the specifications also apply to the exchange of "integrated pumps" *) in existing heat generators

*) "Integrated circulating pump" means a circulating pump intended for operation within a product and having at least one of the following design features:

- a) the pump housing is designed for assembly and use within a product
- b) the circulating pump is designed for speed control by the product
- c) the circulating pump has safety features which do not allow operation outside a product (ISO-IP classes)
- d) the circulating pump is defined as part of the product approval or the CE marking of a product.

As a rule, "integrated circulation pumps" are pumps that have been already installed and delivered with boilers by boiler manufacturers, and which have been distinguished by a special type designation as an integral part of the boiler. In addition to boilers, this can of course also be other products.

All Armstrong heating, solar and geo pumps meet the more stringent ErP requirements.



The reference value for the most efficient circulating pumps is $EEI \leq 0,20$. These pumps will be called the

BEST
in class

Except of the ErP requirements are only drinking water circulation pumps. However, the note "This circulation pump is only suitable for drinking water" must be attached to the packaging and the related technical documentation for drinking water circulation pumps. Armstrong offers both high-efficiency as well as standard drinking water circulation pumps. In order to fully meet the requirements of the Drinking Water Ordinance in Germany, Armstrong has generally converted the material of the pump housing for drinking water circulation pumps to stainless steel.

GERMAN BAFA SUPPORT

The exchange of heating / solar / geo circulation pumps and DHW circulation pumps by highly efficient pumps and the hydraulic compensation is subsidized in Germany starting at August 1, 2016. The BAFA (Federal Office for Economic Affairs and Export Control) is responsible for the implementation. Both cases are subsidized independently or in combination.

Funding is 30% of net material and labor costs. Only high-efficiency pumps with an EEI of ≤ 0.20 are supported.

Details on funding, application and requested forms can be found at www.bafa.de/DE/Energie/Energieeffizienz/Heizungsoptimierung/.

BAFA-eligible pumps in the Armstrong product range, see the "BAFA gefördert" logo.



Similar or complementary support programs may be also available in other municipal and regional areas as well as in other European countries.

High efficiency pumps, electronically controlled

HEP Optimo Basic series, H1 product group



5
YEAR
WARRANTY
★★★★★

ERP
2015⁺

BEST
in class
BAFA
GEFÖRDERT

TECHNICAL DATA

Rate of flow:	up to 4,4 m ³ /h
Pressure head:	4 m/6 m/8 m
Control range:	4-20 W/5-57 W/6-64 W
Media temperature:	+2 °C to +110 °C
Installation length:	130 and 180 mm
Threaded connection:	1", 1½" and 2"
Protection class:	IP 42
Insulation class:	F
Nominal pressure:	PN 10
Control:	Δpc + Δpv + fixed rpm
EEL:	≤ 0.17 HEP Optimo Basic XX-4.0 GXXX ≤ 0.18 HEP Optimo Basic XX-6.0 GXXX ≤ 0.20 HEP Optimo Basic XX-8.0 GXXX

PRODUCT FEATURES

- manual start-up feature
- smooth running
- very low energy consumption
- integrated night economy feature
- air-vent screw
- convenient operation
- space-saving axially integrated terminal box
- automatic adjustment to pressure conditions
- cataphoretic coated pump housing
- pre-mounted cable (1 m)
- compact design

USE

The electronically controlled HEP Optimo Basic high efficiency wet rotor circulators with permanent magnet technology are designed for use in heating systems with variable or constant rate of flow.

MODE OF OPERATION ΔP CONTROL FOR HEATING SYSTEMS

When thermostatic valves in systems with a long main supply heating pipe (likely for radiator systems) close, the total flow drops. This results in lower pipe resistance in this main pipe, which means the pump has to create lower head. Using proportional pressure mode PP (L) is the preferred setting for such heating systems, as here the pump decreases head at lower flow.

If the main supply heating pipe has not to be taken into consideration, because it is short or has its own pump (likely for underfloor heating systems with in mixing units integrated pumps), the best mode to use is constant pressure mode CP (E). In such heating systems, it is important always to have constant pressure for the radiators or ufh-circuits, as the pressure loss in the main pipe is not considered and all other consumers are installed in parallel, which does not influence the maximum pressure loss.

CONTROL MODES FOR USE IN SOLAR SYSTEMS

As a rule, solar systems are designed for constant flow. High differential pressure at low flow is required. The fixed speed mode (M) is recommended for this. With this setting, the pump generates the highest possible differential pressure.

In the case of solar systems with a variable flow rate, the setting „Constant pressure“ (E) can alternatively be selected. Here, the differential pressure is kept constant regardless of the respective hydraulic situation of the solar system.

The „Proportional pressure“ (L) control mode may only be selected if the solar pump is used in a heating system with thermostatic valves.

Important: High efficiency pumps with electronically commutated motor (ECM) and integrated automatic control - such as the HEP Optimo - cannot be operated via external controls, which control pumps via wave packet or leading edge control. The Armstrong series HEP BB2 is recommended for such cases.

MAIN AREAS OF USE

Heating, air-conditioning and industry systems as

- dual pipe system
- underfloor heating
- boiler/primary circuit
- storage charging circuit
- solar systems and heating pumps

MATERIALS

Component	Material	Material no.
Pump housing	Grey-cast iron	0.6020
Impeller	Polyamide (PA - GF 35)	
Shaft	Ceramic	
Bearing	Ceramic	
Bearing plate	Stainless steel	1.4301
Can	Stainless steel	1.4301

FLOW MEDIA

- heating water as per VDI 2035
- pure, thin, non-aggressive and non-explosive, mineral oil-free media without solid or long-fibre components
- media with a max. viscosity of 10 mm²/s
- operating data must be checked above 20 % glycol

TEMPERATURE RANGE

Ambient temperature:	0 °C to +40 °C
Temperature class:	TF 110
Media temperature:	+2 °C to +110 °C

AMBIENT TEMPERATURE

To avoid condensation forming in the terminal box and stator, the media temperature must always be the same or higher than the ambient temperature.

Ambient temp.	Media temp. min.	Media temp. max.
0	2	95
10	10	95
20	20	95
30	30	95
35	35	90
40	40	70

MOTOR PROTECTION

External motor protection is not required.

INTEGRATED NIGHT ECONOMY FEATURE

When the automatic night economy feature is activated, the circulation pump switches between normal mode and economy mode (characteristic curve MIN). The flow temperature is detected by a temperature sensor, the pump reacts accordingly. For this, it is necessary for the circulation pump to be installed in flow.

MINIMUM INFLOW PRESSURE

Please determine the minimum inflow pressure for corresponding temperature from the following table.

Media temperature	< 75 °C	> 90 °C
Minimum inflow pressure	0.05 bar	0.28 bar

SOUND PRESSURE LEVEL

The sound pressure level is < 45 dB (A).

CHOICE OF CONTROL CHARACTERISTIC

You can set 3 different control modes via the potentiometer on the axial terminal box. Proportional pressure (L), fixed speed (M) and constant pressure (E) can be adjusted continuously variable.



TECHNICAL DATA

TYPE	CONNECTION PIPE	THREADED CONNECTION	INSTALLATION LENGTH (MM)	VOLTAGE / FREQUENCY	P1 (W)	I _{max} (A)	NET-WEIGHT (KG)	PRODUCT NO.	EEL
HEP OPTIMO BASIC 25-4.0 G180	1"	1½"	180	230 V 50/60 HZ	4 ... 20	0,26	2,7	0623-34204.2-72	≤ 0,17
HEP OPTIMO BASIC 25-6.0 G180	1"	1½"	180	230 V 50/60 HZ	5 ... 37	0,41	2,7	0623-34206.2-72	≤ 0,18
HEP OPTIMO BASIC 25-8.0 G180	1"	1½"	180	230 V 50/60 HZ	6 ... 64	0,61	2,7	0623-34208.2-72	≤ 0,20
HEP OPTIMO BASIC 30-4.0 G180	1¼"	2"	180	230 V 50/60 HZ	4 ... 20	0,26	2,8	0624-34204.2-72	≤ 0,17
HEP OPTIMO BASIC 30-6.0 G180	1¼"	2"	180	230 V 50/60 HZ	5 ... 37	0,41	2,8	0624-34206.2-72	≤ 0,18
HEP OPTIMO BASIC 30-8.0 G180	1¼"	2"	180	230 V 50/60 HZ	6 ... 64	0,61	2,8	0624-34208.2-72	≤ 0,20
HEP OPTIMO BASIC 15-4.0 G130	½"	1"	130	230 V 50/60 HZ	4 ... 20	0,26	2,3	0621-34004.2-72	≤ 0,17
HEP OPTIMO BASIC 15-6.0 G130	½"	1"	130	230 V 50/60 HZ	5 ... 37	0,41	2,3	0621-34006.2-72	≤ 0,18
HEP OPTIMO BASIC 15-8.0 G130	½"	1"	130	230 V 50/60 HZ	6 ... 64	0,61	2,3	0621-34008.2-72	≤ 0,20
HEP OPTIMO BASIC 20-4.0 G130	¾"	1 ¼"	130	230 V 50/60 HZ	4 ... 20	0,26	2,4	0622-34004.2-72	≤ 0,17
HEP OPTIMO BASIC 20-6.0 G130	¾"	1 ¼"	130	230 V 50/60 HZ	5 ... 37	0,41	2,4	0622-34006.2-72	≤ 0,18
HEP OPTIMO BASIC 20-8.0 G130	¾"	1 ¼"	130	230 V 50/60 HZ	6 ... 64	0,61	2,4	0622-34008.2-72	≤ 0,20
HEP OPTIMO BASIC 25-4.0 G130	1"	1½"	130	230 V 50/60 HZ	4 ... 20	0,26	2,5	0623-34004.2-72	≤ 0,17
HEP OPTIMO BASIC 25-6.0 G130	1"	1½"	130	230 V 50/60 HZ	5 ... 37	0,41	2,5	0623-34006.2-72	≤ 0,18
HEP OPTIMO BASIC 25-8.0 G130	1"	1½"	130	230 V 50/60 HZ	6 ... 64	0,61	2,5	0623-34008.2-72	≤ 0,20

CONSTANT PRESSURE

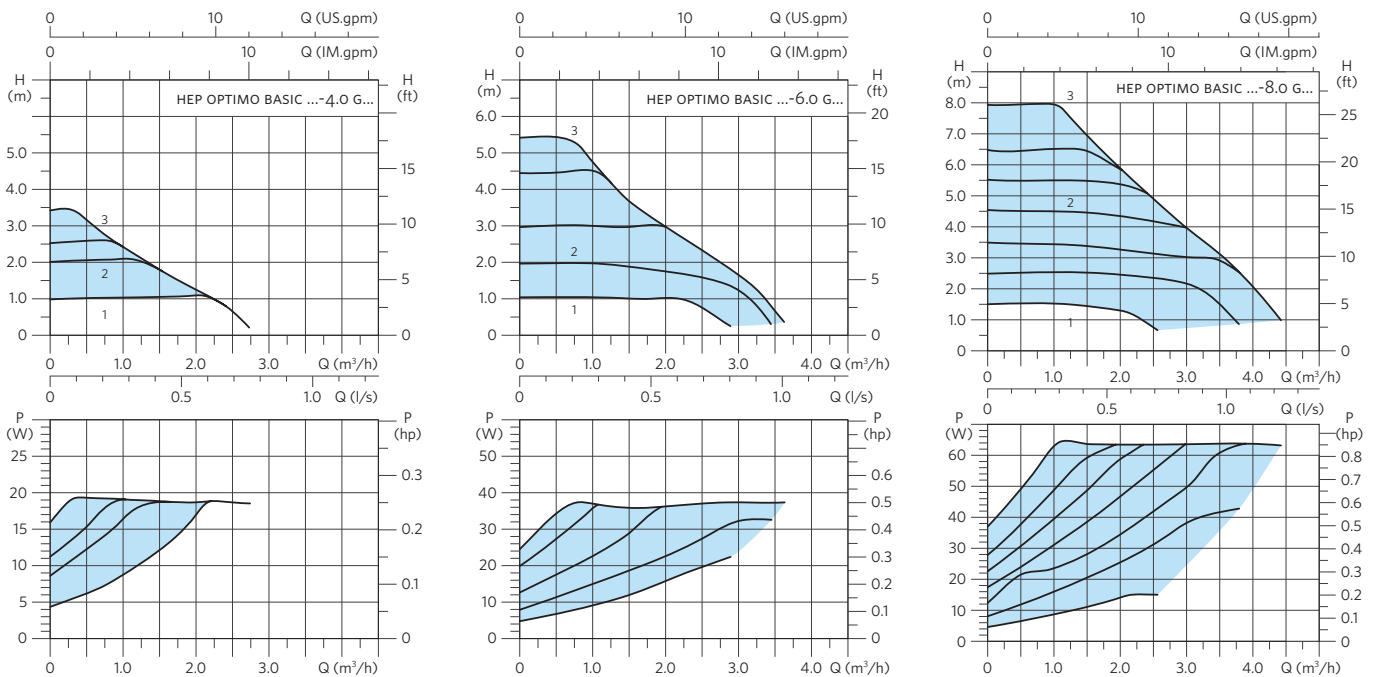

High efficiency pumps, electronically controlled

HEP Optimo Basic series, H1 product group

PROPORTIONAL PRESSURE

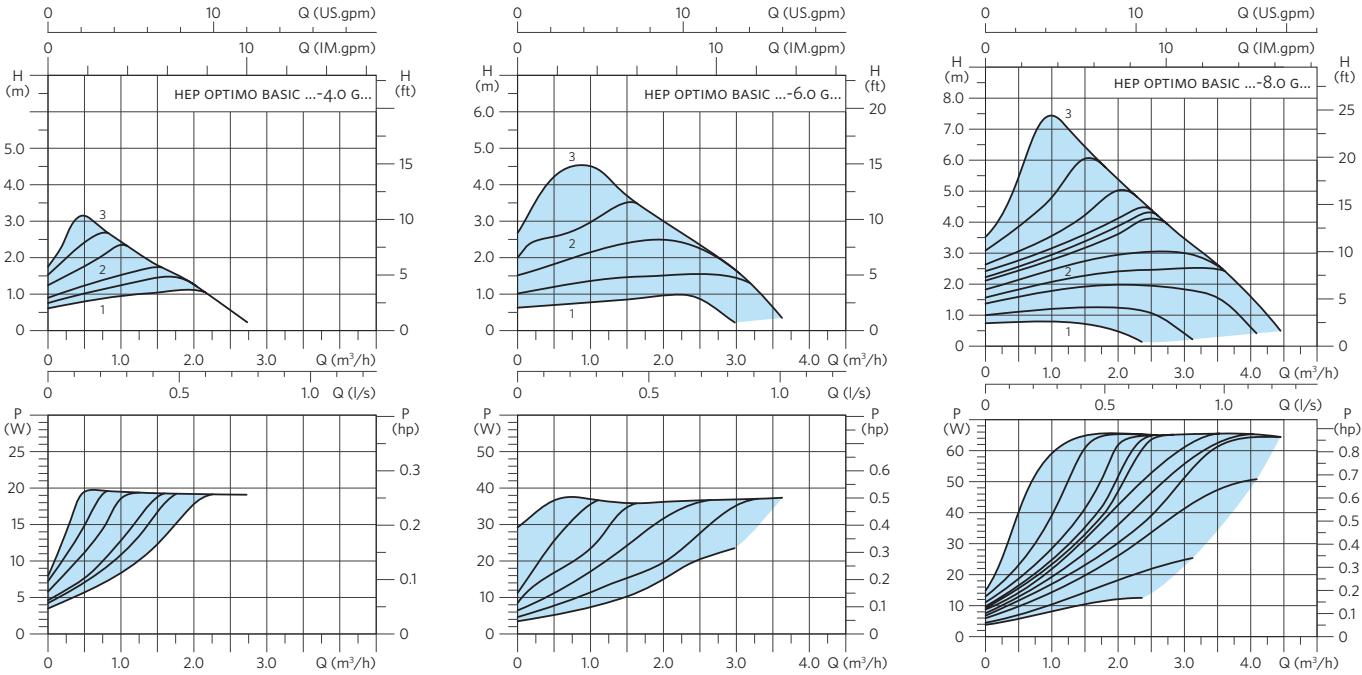

FIXED RPM

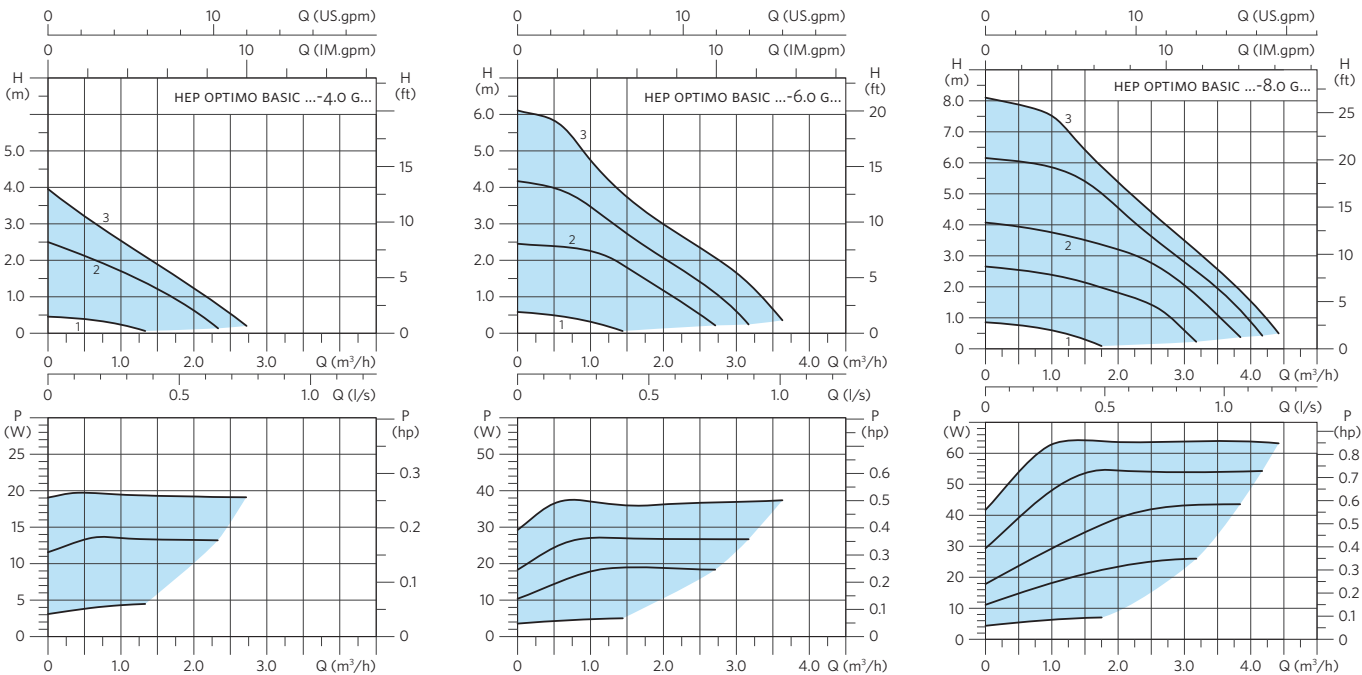

DIMENSIONS

TYPE	L1 (MM)	L2 (MM)	L3 (MM)	L4 (MM)
HEP OPTIMO BASIC	130/180	98	127	163

DIMENSION ILLUSTRATION

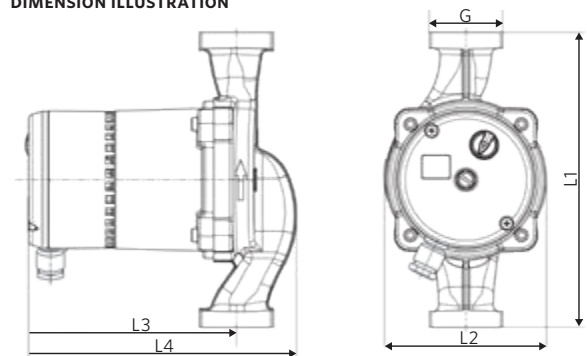

High efficiency pumps with LED display, electronically controlled

HEP Optimo series, H1 product group



Insulation shell
with installation length
180 mm included
in delivery.

**BEST
in class**

**ERP
2015⁺**

**5
YEAR
WARRANTY**
★★★★★

**BAFA
GEFÖRDERT**

TECHNICAL DATA

Rate of flow:	up to 4.4 m ³ /h
Pressure head:	4 m/6 m/8 m
Control range:	4-20 W/5-37 W/6-64 W
Media temperature:	+2 °C to +110 °C
Installation length:	130 and 180 mm
Threaded connection:	1", 1½" and 2"
Protection class:	IP 42
Insulation class:	F
Nominal pressure:	PN 10
Control:	Δpc + Δpv + fixed rpm
EEL:	≤ 0.17 HEP Optimo XX-4.0 GXXX ≤ 0.18 HEP Optimo XX-6.0 GXXX ≤ 0.20 HEP Optimo XX-8.0 GXXX

PRODUCT FEATURES

- manual start-up feature
- smooth running
- very low energy consumption
- integrated night economy feature
- air-vent screw
- LED display
- convenient operation
- space-saving axially integrated terminal box
- automatic adjustment to pressure conditions
- cataphoretic coated pump housing
- pre-mounted, screwable angle entry-plug
- compact design

USE

The electronically controlled HEP Optimo high efficiency wet rotor circulators with LED display and permanent magnet technology are designed for use in heating and solar systems as well as for boiler storage loading. The cataphoretic coated pump housing is stainless.

MODE OF OPERATION ΔP CONTROL IN HEATING SYSTEMS

When thermostatic valves in systems with a long main supply heating pipe (likely for radiator systems) close, the total flow drops. This results in lower pipe resistance in this main pipe, which means the pump has to create lower head. Using proportional pressure mode (L) is the preferred setting for such heating systems, as here the pump decreases head at lower flow.

If the main supply heating pipe has not to be taken into consideration, because it is short or has its own pump (likely for underfloor heating systems with in mixing units integrated pumps), the best mode to use is constant pressure mode (E). In such heating systems, it is important always to have constant pressure for the radiators or ufh-circuits, as the pressure loss in the main pipe is not considered and all other consumers are installed in parallel, which does not influence the maximum pressure loss.

CONTROL MODES FOR USE IN SOLAR SYSTEMS

As a rule, solar systems are designed for constant flow. High differential pressure at low flow is required. The fixed speed mode (M) is recommended for this. With this setting, the pump generates the highest possible differential pressure.

In the case of solar systems with a variable flow rate, the setting „Constant pressure“ (E) can alternatively be selected. Here, the differential pressure is kept constant regardless of the respective hydraulic situation of the solar system.

The „Proportional pressure“ (L) control mode may only be selected if the solar pump is used in a heating system with thermostatic valves.

Important: High efficiency pumps with electronically commutated motor (ECM) and integrated automatic control - such as the HEP Optimo - cannot be operated via external controls, which control pumps via wave packet or leading edge control. The Armstrong series HEP BB2 is recommended for such cases.

MAIN AREAS OF USE

Heating, air-conditioning and industry systems as

- dual pipe system
- underfloor heating
- boiler/primary circuit
- storage charging circuit
- solar systems and heating pumps

MATERIALS

Component	Material	Material no.
Pump housing	Grey-cast iron	0.6020
Impeller	Polyamide (PA - GF 35)	
Shaft	Ceramic	
Bearing	Ceramic	
Bearing plate	Stainless steel	1.4301
Can	Stainless steel	1.4301

FLOW MEDIA

- heating water as per VDI 2035
- pure, thin, non-aggressive and non-explosive, mineral oil-free media without solid or long-fibre components
- media with a max. viscosity of 10 mm²/s
- operating data must be checked above 20 % glycol

TEMPERATURE RANGE

Ambient temperature:	0 °C to +40 °C
Temperature class:	TF 110
Media temperature:	+2 °C to +110 °C

AMBIENT TEMPERATURE

To avoid condensation forming in the terminal box and stator, the media temperature must always be the same or higher than the ambient temperature.

Ambient temp.	Media temp. min.	Media temp. max.
0	2	110
10	10	110
20	20	110
30	30	95
35	35	90
40	40	70

MOTOR PROTECTION

External motor protection is not required.

INTEGRATED NIGHT ECONOMY FEATURE

When the automatic night economy feature is activated, the circulation pump switches between normal mode and economy mode (characteristic curve MIN). The flow temperature is detected by a temperature sensor, the pump reacts accordingly. For this, it is necessary for the circulation pump to be installed in flow.

MINIMUM INFLOW PRESSURE

Please determine the minimum inflow pressure for corresponding temperature from the following table.

Media temperature	< 75 °C	> 90 °C
Minimum inflow pressure	0.05 bar	0.28 bar

SOUND PRESSURE LEVEL

The sound pressure level is < 45 dB (A).

CHOICE OF CONTROL CHARACTERISTIC

You can set 3 different control modes via the potentiometer on the axial terminal box. Proportional pressure (L), fixed speed (M) and constant pressure (E) can be adjusted continuously variable. The display indicates power consumption in [W] watts. Once the potentiometer is turned, the flashing display first indicates mode of operation and value of set head in [m] meters. If not further turned the display shows the value of power consumption (Watt) and the symbol of the control mode permanently.



High efficiency pumps with LED display, electronically controlled

HEP Optimo series, H1 product group

TECHNICAL DATA

TYPE	CONNECTION PIPE	THREADED CONNECTION	INSTALLATION LENGTH (MM)	VOLTAGE / FREQUENCY	P1 (W)	I _{MAX} (A)	NET-WEIGHT (KG)	PRODUCT NO.	EEL
HEP OPTIMO 25-4.0 G180	1"	1½"	180	230 V 50/60 HZ	4 ... 20	0,26	2,7	0623-34204.1-72	≤ 0,17
HEP OPTIMO 25-6.0 G180	1"	1½"	180	230 V 50/60 HZ	5 ... 37	0,41	2,7	0623-34206.1-72	≤ 0,18
HEP OPTIMO 25-8.0 G180	1"	1½"	180	230 V 50/60 HZ	6 ... 64	0,61	2,7	0623-34208.1-72	≤ 0,20
HEP OPTIMO 30-4.0 G180	1¼"	2"	180	230 V 50/60 HZ	4 ... 20	0,26	2,8	0624-34204.1-72	≤ 0,17
HEP OPTIMO 30-6.0 G180	1¼"	2"	180	230 V 50/60 HZ	5 ... 37	0,41	2,8	0624-34206.1-72	≤ 0,18
HEP OPTIMO 30-8.0 G180	1¼"	2"	180	230 V 50/60 HZ	6 ... 64	0,61	2,8	0624-34208.1-72	≤ 0,20
HEP OPTIMO 15-4.0 G130	½"	1"	130	230 V 50/60 HZ	4 ... 20	0,26	2,3	0621-34004.1-72	≤ 0,17
HEP OPTIMO 15-6.0 G130	½"	1"	130	230 V 50/60 HZ	5 ... 37	0,41	2,3	0621-34006.1-72	≤ 0,18
HEP OPTIMO 15-8.0 G130	½"	1"	130	230 V 50/60 HZ	6 ... 64	0,61	2,3	0621-34008.1-72	≤ 0,20
HEP OPTIMO 20-4.0 G130	¾"	1¼"	130	230 V 50/60 HZ	4 ... 20	0,26	2,4	0622-34004.1-72	≤ 0,17
HEP OPTIMO 20-6.0 G130	¾"	1¼"	130	230 V 50/60 HZ	5 ... 37	0,41	2,4	0622-34006.1-72	≤ 0,18
HEP OPTIMO 20-8.0 G130	¾"	1¼"	130	230 V 50/60 HZ	6 ... 64	0,61	2,4	0622-34008.1-72	≤ 0,20
HEP OPTIMO 25-4.0 G130	1"	1½"	130	230 V 50/60 HZ	4 ... 20	0,26	2,5	0623-34004.1-72	≤ 0,17
HEP OPTIMO 25-6.0 G130	1"	1½"	130	230 V 50/60 HZ	5 ... 37	0,41	2,5	0623-34006.1-72	≤ 0,18
HEP OPTIMO 25-8.0 G130	1"	1½"	130	230 V 50/60 HZ	6 ... 64	0,61	2,5	0623-34008.1-72	≤ 0,20

CONSTANT PRESSURE

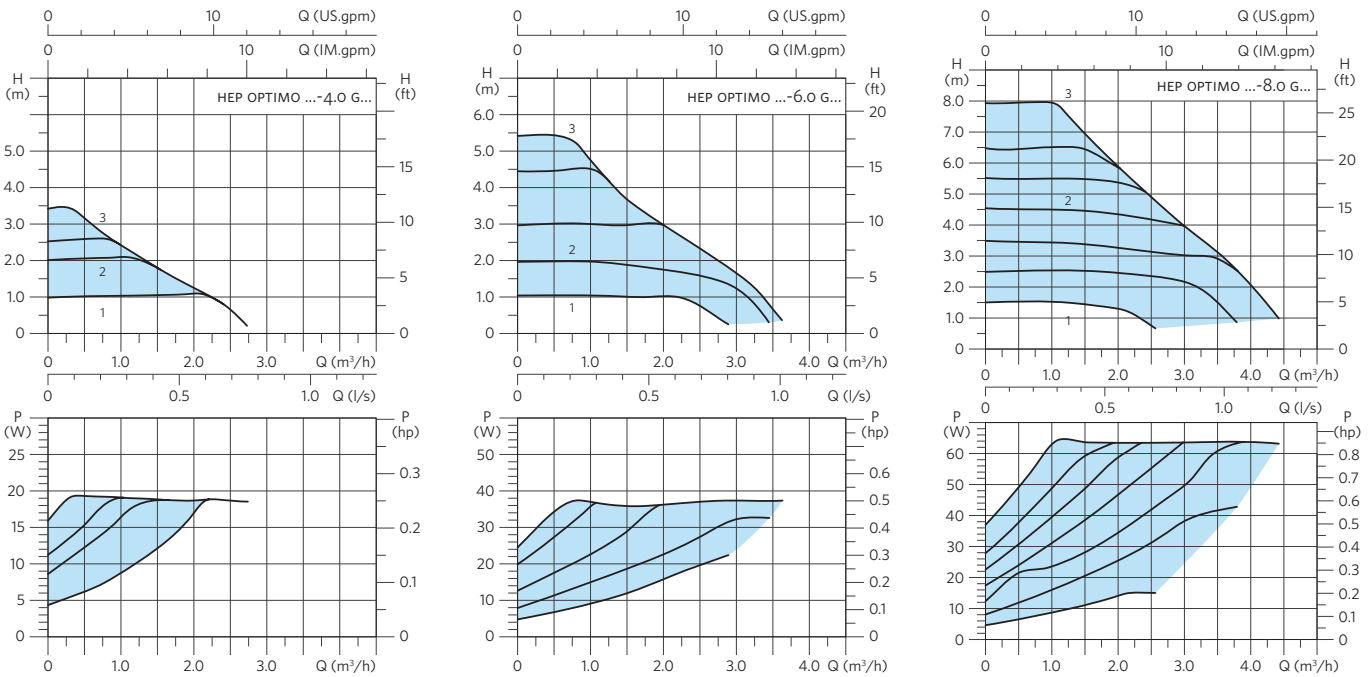

High efficiency pumps with LED display, electronically controlled

HEP Optimo series, H1 product group

PROPORTIONAL PRESSURE

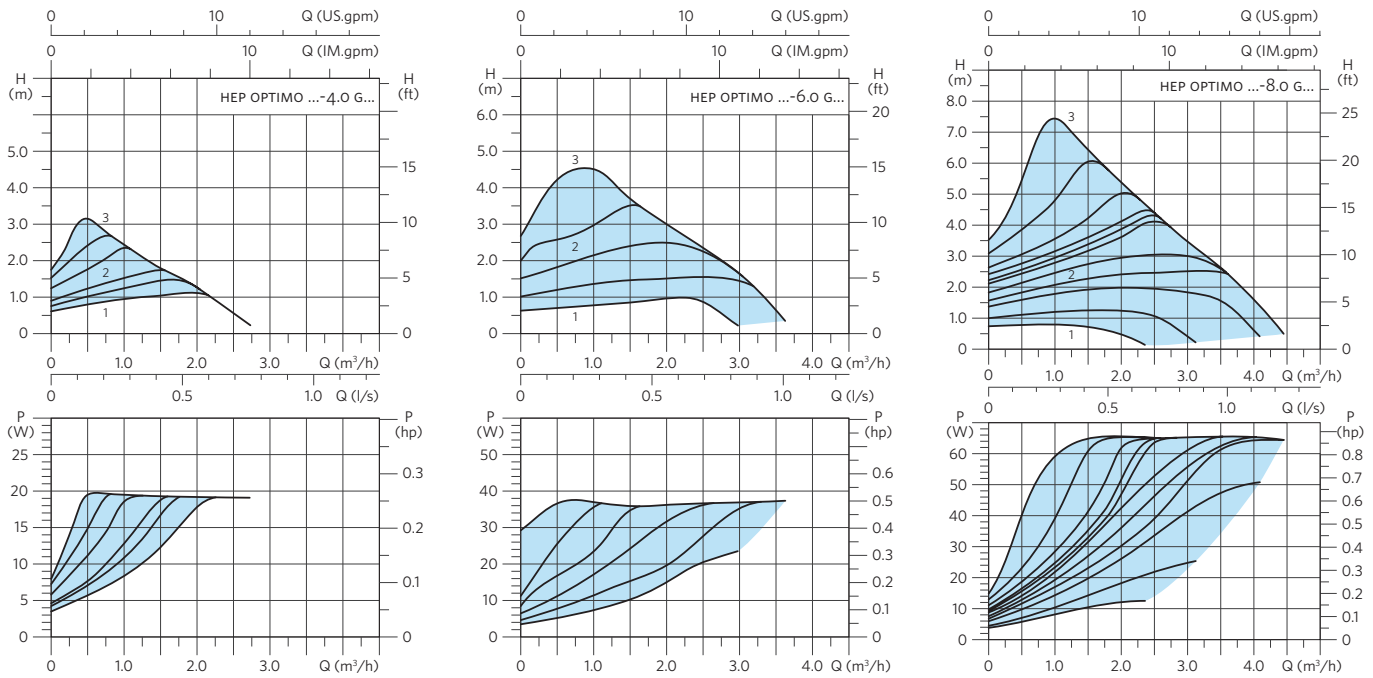

FIXED RPM

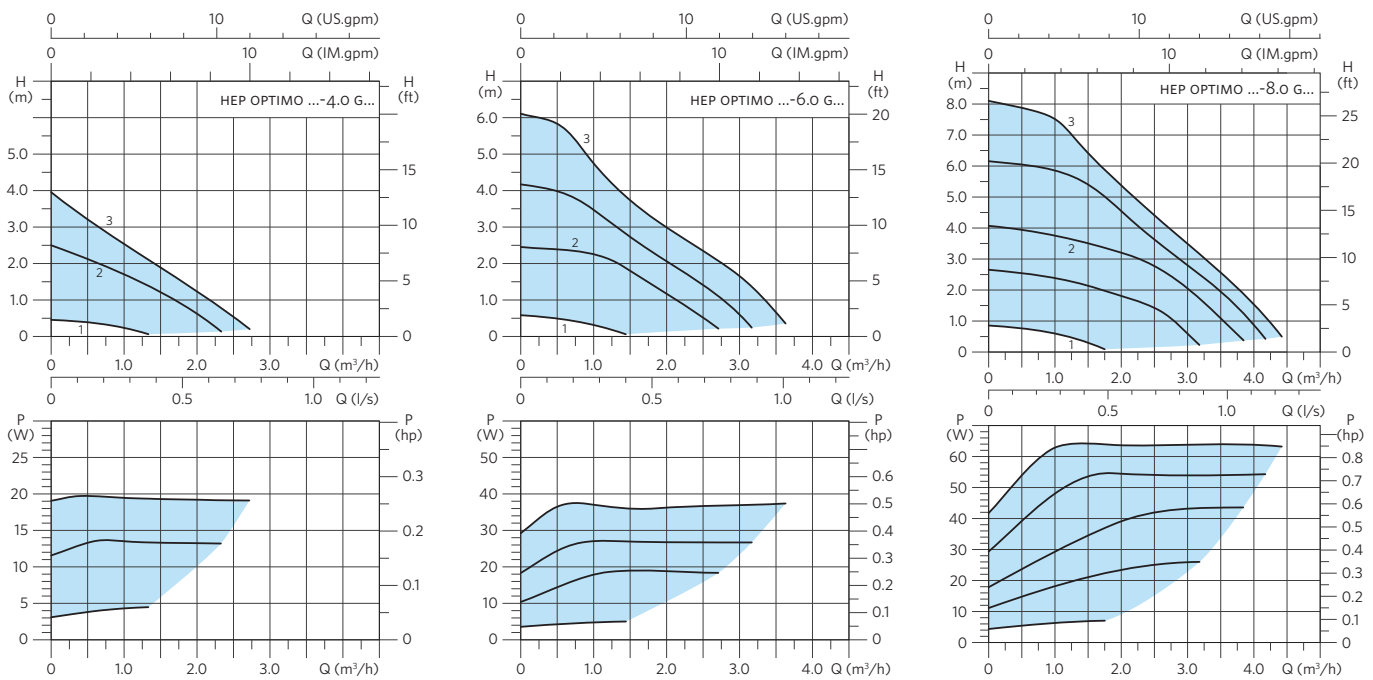

DIMENSIONS

TYPE	L1 (MM)	L2 (MM)	L3 (MM)	L4 (MM)
HEP OPTIMO	130/180	98	127	163

DIMENSION ILLUSTRATION

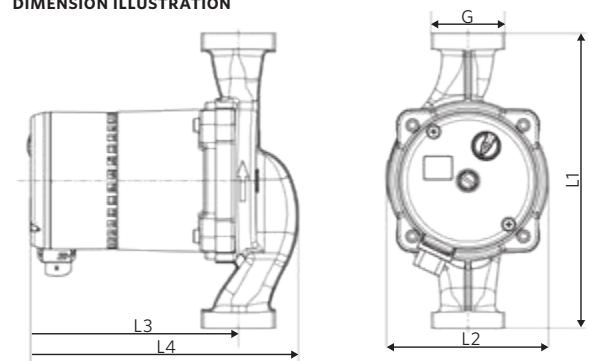

High efficiency pumps with LCD display, electronically controlled

HEP Optimo L series, H2 product group



Insulation shell
with installation length
180 mm included
in delivery.



TECHNICAL DATA

Rate of flow:	up to 10 m ³ /h
Pressure head:	8 m/10 m
Control range:	15-180 W/15-195 W
Media temperature:	+2 °C to +95 °C
Installation length:	180 mm (threaded)/220 mm (flanged)
Circulator connection:	1½" and 2" (threaded)/DN 32 and 40 (flanged)
Protection class:	IP 42
Insulation class:	F
Nominal pressure:	PN 10
EEl:	≤ 0.23 HEP Optimo L XX-8.0 GXXX ≤ 0.23 HEP Optimo L XX-10.0 GXXX

Control:

Internal:	$\Delta p_c + \Delta p_v$ + fixed rpm
External:	<ul style="list-style-type: none"> digital: PWM (characteristic lines for heating and solar per VDMA device paper 24224) frequency f nominal: 100-1000 Hz voltage U nominal: 5-15 V power I: 10 mA analogue: 0-10 V with cable break detection power I: 1 mA impedance: 10 kOhm

Omnibus fault message: Selector switch, potential-free, power max.
2 A/240 VAC

Power supply for external unit: Voltage DC 12 V, power max. 100 mA

PRODUCT FEATURES

- LCD display
- manual start-up feature
- smooth running
- very low energy consumption
- air-vent screw
- collective fault signal
- convenient operation
- axially integrated terminal box
- automatic adjustment to pressure conditions
- cathaphoretic coated pump housing

USE

The electronically controlled HEP Optimo L high efficiency wet rotor circulators with LCD display and permanent magnet technology are designed for use in heating systems with variable or constant rate of flow. The cathaphoretic coated pump housing is stainless.

MAIN AREAS OF USE

Heating, air-conditioning and industry systems as

- dual pipe system
- single pipe system
- underfloor heating
- boiler/primary circuit
- storage charging circuit
- solar systems and heating pumps

CONTROLS FUNCTION

You can make adjustments with the integrated control keys at the front. The LCD display shows the total electrical input power as a numeric value in [W] watts. Different icons at the top of the display show the function, setting and the modes of operation.

MATERIALS

Component	Material	Material No.
Pump body	Grey-cast iron	0.6020
Impeller	Polyamide (PA - GF 35)	
Shaft	Ceramic	
Bearing	Ceramic	
Bearing plate	Stainless steel	1.4301
Can	Stainless steel	1.4301

FLOW MEDIA

- heating water as per VDI 2035
- pure, thin, non-aggressive and non-explosive, mineral oil-free media without solid or long-fibre components
- media with a max. viscosity of 10 mm²/s
- operating data must be checked above 20 % glycol

TEMPERATURE RANGE

Ambient temperature:	0 °C to +40 °C
Temperature class:	TF 95
Media temperature:	+2 °C to +95 °C

AMBIENT TEMPERATURE

To avoid condensation forming in the terminal box and stator, the media temperature must always be the same or higher than the ambient temperature.

Ambient temp.	Media temp. min.	Media temp. max.
0	2	95
10	10	95
20	20	95
30	30	95
35	35	90
40	40	70

MOTOR PROTECTION

External motor protection is not required.

MINIMUM INFLOW PRESSURE

Please determine the minimum inflow pressure for corresponding temperature from the following table.

Media temperature	< 75 °C	> 90 °C
Minimum inflow pressure	0.05 bar	0.45 bar

SOUND PRESSURE LEVEL

The sound pressure level is < 45 dB (A).

High efficiency pumps with LCD display, electronically controlled

HEP Optimo L series, H2 product group

TECHNICAL DATA

TYPE	CONNECTION PIPE	THREADED CONNECTION	FLANGE	INSTALLATION LENGTH (MM)	VOLTAGE / FREQUENCY	P1 (W)	I _{MAX} (A)	NET-WEIGHT (KG)	PRODUCT NO.	EEI
HEP OPTIMO L 25-8.0 G180	1"	1½"	-	180	230 V 50/60 HZ	15 ... 180	0,90	6.0	0323-64208.1-72	≤ 0.23
HEP OPTIMO L 25-10.0 G180	1"	1½"	-	180	230 V 50/60 HZ	15 ... 195	0,90	6.0	0323-64210.1-72	≤ 0.23
HEP OPTIMO L 30-8.0 G180	1¼"	2"	-	180	230 V 50/60 HZ	15 ... 180	0,90	6.0	0324-64208.1-72	≤ 0.23
HEP OPTIMO L 30-10.0 G180	1¼"	2"	-	180	230 V 50/60 HZ	15 ... 195	0,90	6.0	0324-64210.1-72	≤ 0.23
HEP OPTIMO L 32-8.0 G220	-	-	DN 32	220	230 V 50/60 HZ	15 ... 180	0,90	6.1	0324-94208.1-72	≤ 0.23
HEP OPTIMO L 32-10.0 G220	-	-	DN 32	220	230 V 50/60 HZ	15 ... 195	0,90	6.1	0324-94210.1-72	≤ 0.23
HEP OPTIMO L 40-8.0 G220	-	-	DN 40	220	230 V 50/60 HZ	15 ... 180	0,90	6.1	0325-94208.1-72	≤ 0.23
HEP OPTIMO L 40-10.0 G220	-	-	DN 40	220	230 V 50/60 HZ	15 ... 195	0,90	6.1	0325-94210.1-72	≤ 0.23

PROPORTIONAL PRESSURE

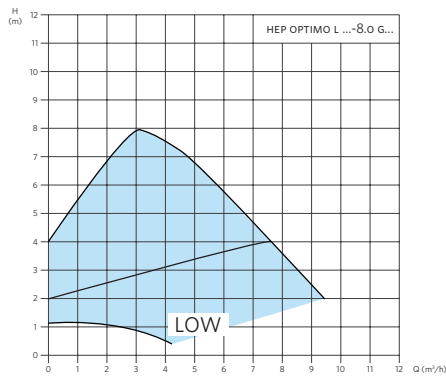

CONSTANT PRESSURE

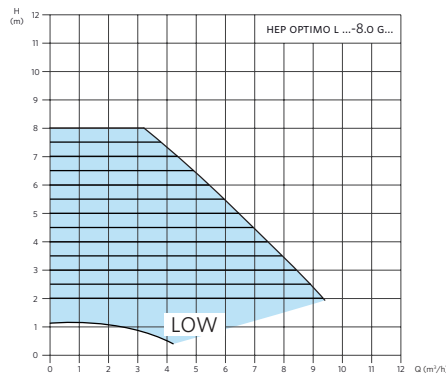

FIXED RPM

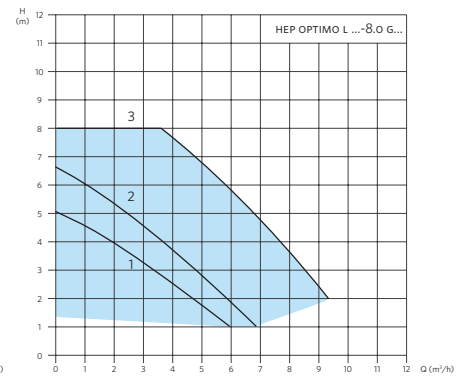

PROPORTIONAL PRESSURE

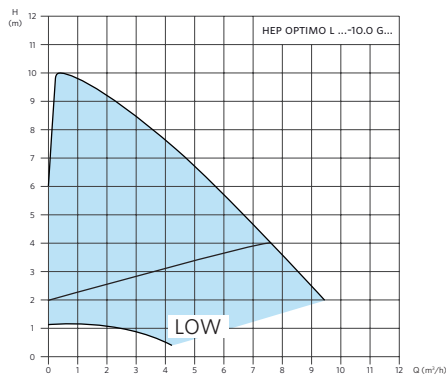

CONSTANT PRESSURE

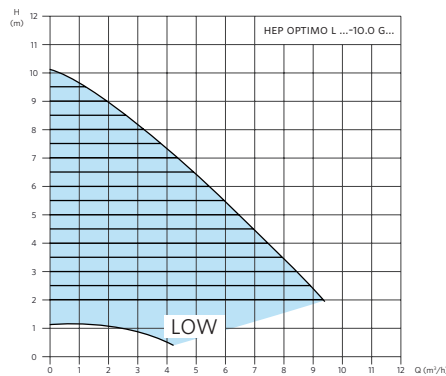

FIXED RPM

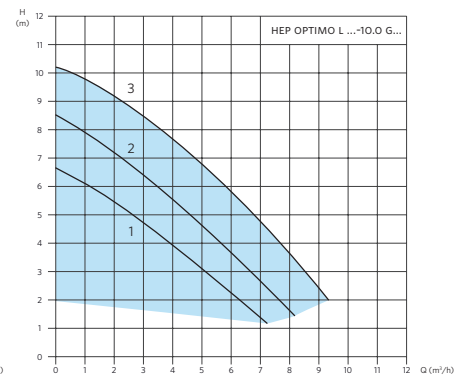

DIMENSIONS

TYPE	L1 (MM)	L2 (MM)	L3 (MM)	L4 (MM)
HEP OPTIMO L (THREAD)	180	267	178	225
HEP OPTIMO L (FLANGE)	220	267	177.5	245

DIMENSION ILLUSTRATION

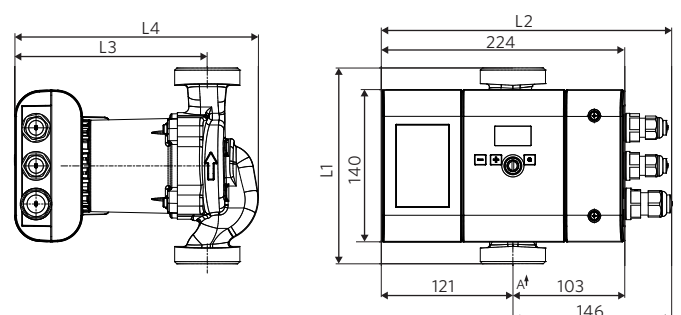

High efficiency pumps with LCD display, electronically controlled

HEP Optimo L+ series, H2 product group



Insulation shell included in delivery.

5 YEAR WARRANTY
★★★★★

BEST in class

ERP 2015+

BAFA GEFÖRDERT

TECHNICAL DATA

Rate of flow:	7 to 45 m ³ /h depending on model
Pressure head:	6 m/8 m/10 m/12 m
Control range:	6 to 760 W depending on model
Media temperature:	-10 °C (non freezing) to +110 °C
Installation length:	180 to 340 mm depending on model
Circulator connection:	1½" and 2" (threaded) DN 32, 40, 50 and 65 (flanged)
Protection class:	IP 44
Insulation class:	F
Nominal pressure:	PN 10

Control

Internal:	Δpc + Δpv + Eco Mode + fixed rpm
External:	analogue 0-10 V Start/Stop (bridged terminal ex works)

Omnibus fault message: Selector switch, potential free.

PRODUCT FEATURES

- High-efficiency wet running circulator with integrated automatic modes and additional eco mode for additional savings of approx. 40% compared to the best proportional pressure control.
- Convenient operation with multi-knob and dip switch.
- Optional night mode and locking against unauthorized adjustment.
- Clear display of function, setting and operating status via backlit icons and LCD display.
- Connection possibility of external control (0-10 V, start/stop signal) and omnibus fault indication.
- Numerous integrated additional functions (autom. air ventilation, soft-start/inrush current limitation, anti blockage function, electronic motor protection against thermal overload).
- High-quality manufacturing and standard insulation shells.

USE

The wet-running high-efficiency circulators HEP Optimo L+ have an electronically commutated synchronous motor with permanent magnet rotor and a continuously variable differential pressure control. They are designed for use in circulating systems with variable or constant flow. The inline pump housings are resistant to corrosion by a cathodic electrodeposition coating. The HEP Optimo L+ are designed for a static operating pressure of 10 bar.

MAIN AREAS OF USE

Heating, air conditioning/refrigeration, solar, heat pumps and industrial facilities as

- dual pipe system
- single pipe system
- panel systems like underfloor heating
- boiler and primary circuit
- storage loading circuit

CONTROLS FUNCTION

With the multi-function button, all settings can be made easily and quickly. The multi-function button consists of an outer dial for the selection of the desired mode and the power set values, and an internal activation pushbutton for the programming start and for the confirmation of the selected mode or the power set point. Lit symbols in the motor cap

indicate which mode has been active or selected. By pressing the activation pushbutton for more than 30 seconds, the pump is reset to factory default settings. 10 LED segments located around the outer dial show blue enlightened for the selected power values (10-100% of maximum curve). The display shows alternately head, flow rate and power consumption. In cases of disturbances the icon SERVICE lights and additional error codes shown on the display enable a rapid troubleshooting. DIP switches located in the Circulator terminal box can be used optionally for locking against unauthorized adjustment and/or for an activation of the night setback mode.

MATERIALS

Component	Material	Material no.
Pump housing	Grey cast iron, KTL	EN-GJL-200
Impeller	Plastic with fiberglass	PSU-GF30
Shaft	Stainless steel	1.4034
Bearing	Ceramic/Graphite	
Can	Stainless steel	1.4301
Insulation shell	Polypropylen	

FLOW MEDIA

- heating water as per VDI 2035
- pure, thin, non-aggressive and non-explosive, mineral oil-free media without solid or long-fibre components
- media with a max. viscosity of 10 mm²/s
- operating data must be checked above 20 % glycol

TEMPERATURE RANGE

Ambient temperature:	0 °C to +40 °C
Temperature class:	TF 110
Media temperature:	-10 °C (non-freezing) to +110 °C

AMBIENT TEMPERATURE

To avoid condensation on the pump housing, the media temperature should always be equal to or higher than the ambient temperature (see table).

Otherwise, as well as for temperatures from -10 °C to +5 °C, we recommend using a diffusion-tight insulation shell (see accessories).

Ambient temperature	Media temperature min.	Media temperature max.
0 °C	2 °C	110 °C
10 °C	10 °C	110 °C
20 °C	20 °C	110 °C
30 °C	30 °C	110 °C
35 °C	35 °C	100 °C
40 °C	40 °C	90 °C

MOTOR PROTECTION

An external motor protection is not required. The integrated electronic motor protection automatically reduces the power at overload. Simultaneously, a warning appears on the display.

MINIMUM INFLOW PRESSURE

To avoid cavitation noise and circulator damage the following minimum inlet pressure must be maintained at the pump suction nozzle. The values apply up to 300 m above sea level. Otherwise, a surcharge of 0.01 bar per 100 m time should be added.

Media temperature	< 80 °C	> 80 °C to < 95 °C
Minimum inflow pressure	0,5 bar	1,5 bar

SOUND PRESSURE LEVEL

The sound pressure level is ≤ 45 dB (A).

Technical data

TYPE	CONNECTION PIPE	THREADED CONNECTION	FLANGE	INSTALLATION LENGTH (MM)	VOLTAGE / FREQUENCY	P1 (W)	I _{MAX} (A)	NET-WEIGHT (KG)	PRODUCT NO.	EEL
HEP OPTIMO L+ 25-6.0 G180	1"	1 1/2"		180	230 V 50/60 HZ	6 ... 112	0.03 ... 0.50	4.6	0323-92060-72	≤ 0.20
HEP OPTIMO L+ 25-8.0 G180	1"	1 1/2"		180	230 V 50/60 HZ	6 ... 145	0.03 ... 0.63	4.6	0323-92080-72	≤ 0.20
HEP OPTIMO L+ 25-10.0 G180	1"	1 1/2"		180	230 V 50/60 HZ	6 ... 175	0.03 ... 0.80	4.6	0323-92100-72	≤ 0.20
HEP OPTIMO L+ 30-6.0 G180	1 1/4"	2"		180	230 V 50/60 HZ	6 ... 112	0.03 ... 0.50	5.1	0324-92060-72	≤ 0.20
HEP OPTIMO L+ 30-8.0 G180	1 1/4"	2"		180	230 V 50/60 HZ	6 ... 145	0.03 ... 0.63	5.1	0324-92080-72	≤ 0.20
HEP OPTIMO L+ 30-10.0 G180	1 1/4"	2"		180	230 V 50/60 HZ	6 ... 175	0.03 ... 0.80	5.1	0324-92100-72	≤ 0.20
HEP OPTIMO L+ 30-12.0 G180	1 1/4"	2"		180	230 V 50/60 HZ	9 ... 350	0.04 ... 1.50	6.4	0324-92120-72	≤ 0.20
HEP OPTIMO L+ 32-12.0 G220			DN 32	220	230 V 50/60 HZ	9 ... 350	0.04 ... 1.50	9.3	0324-93120-72	≤ 0.20
HEP OPTIMO L+ 40-6.0 G220			DN 40	220	230 V 50/60 HZ	7 ... 110	0.03 ... 0.48	8.0	0325-93060-72	≤ 0.20
HEP OPTIMO L+ 40-8.0 G220			DN 40	220	230 V 50/60 HZ	10 ... 265	0.04 ... 1.15	11.1	0325-93080-72	≤ 0.20
HEP OPTIMO L+ 40-10.0 G220			DN 40	220	230 V 50/60 HZ	10 ... 350	0.04 ... 1.50	11.1	0325-93100-72	≤ 0.20
HEP OPTIMO L+ 40-12.0 G250			DN 40	250	230 V 50/60 HZ	46 ... 611	0.20 ... 2.70	20.3	0325-93120-72	≤ 0.20
HEP OPTIMO L+ 50-6.0 G240			DN 50	240	230 V 50/60 HZ	10 ... 275	0.04 ... 1.20	12.6	0326-93060-72	≤ 0.20
HEP OPTIMO L+ 50-8.0 G240			DN 50	240	230 V 50/60 HZ	10 ... 350	0.04 ... 1.50	12.6	0326-93080-72	≤ 0.20
HEP OPTIMO L+ 50-10.0 G280			DN 50	280	230 V 50/60 HZ	38 ... 476	0.16 ... 2.10	21.0	0326-93100-72	≤ 0.20
HEP OPTIMO L+ 50-12.0 G280			DN 50	280	230 V 50/60 HZ	46 ... 620	0.20 ... 2.70	21.0	0326-93120-72	≤ 0.20
HEP OPTIMO L+ 65-6.0 G340			DN 65	340	230 V 50/60 HZ	15 ... 350	0.07 ... 1.50	16.6	0327-93060-72	≤ 0.20
HEP OPTIMO L+ 65-12.0 G340			DN 65	340	230 V 50/60 HZ	55 ... 760	0.24 ... 3.30	29.5	0327-93120-72	≤ 0.20

PERFORMANCE CURVES

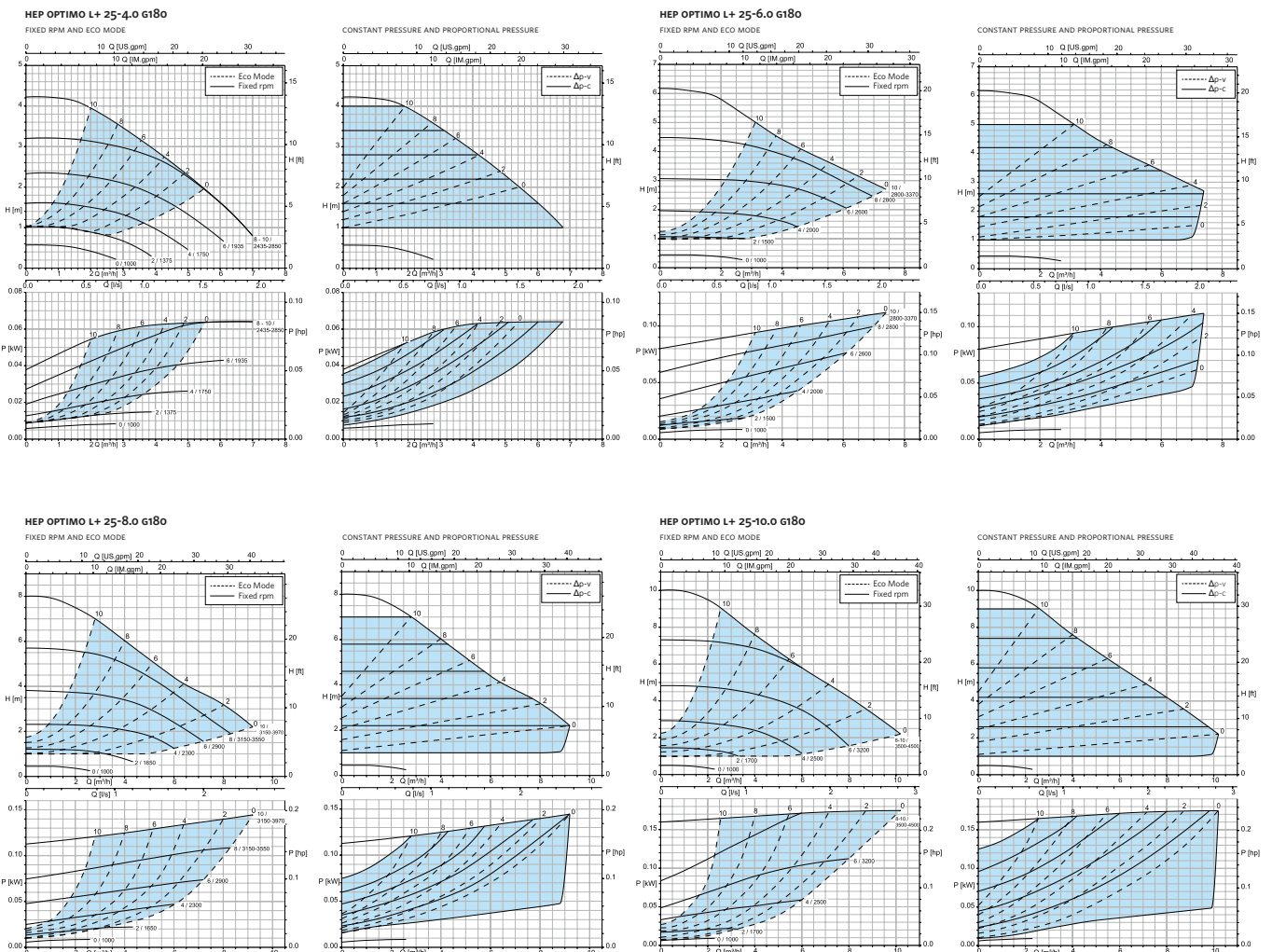

High efficiency pumps with LCD display, electronically controlled

HEP Optimo L+ series, H2 product group

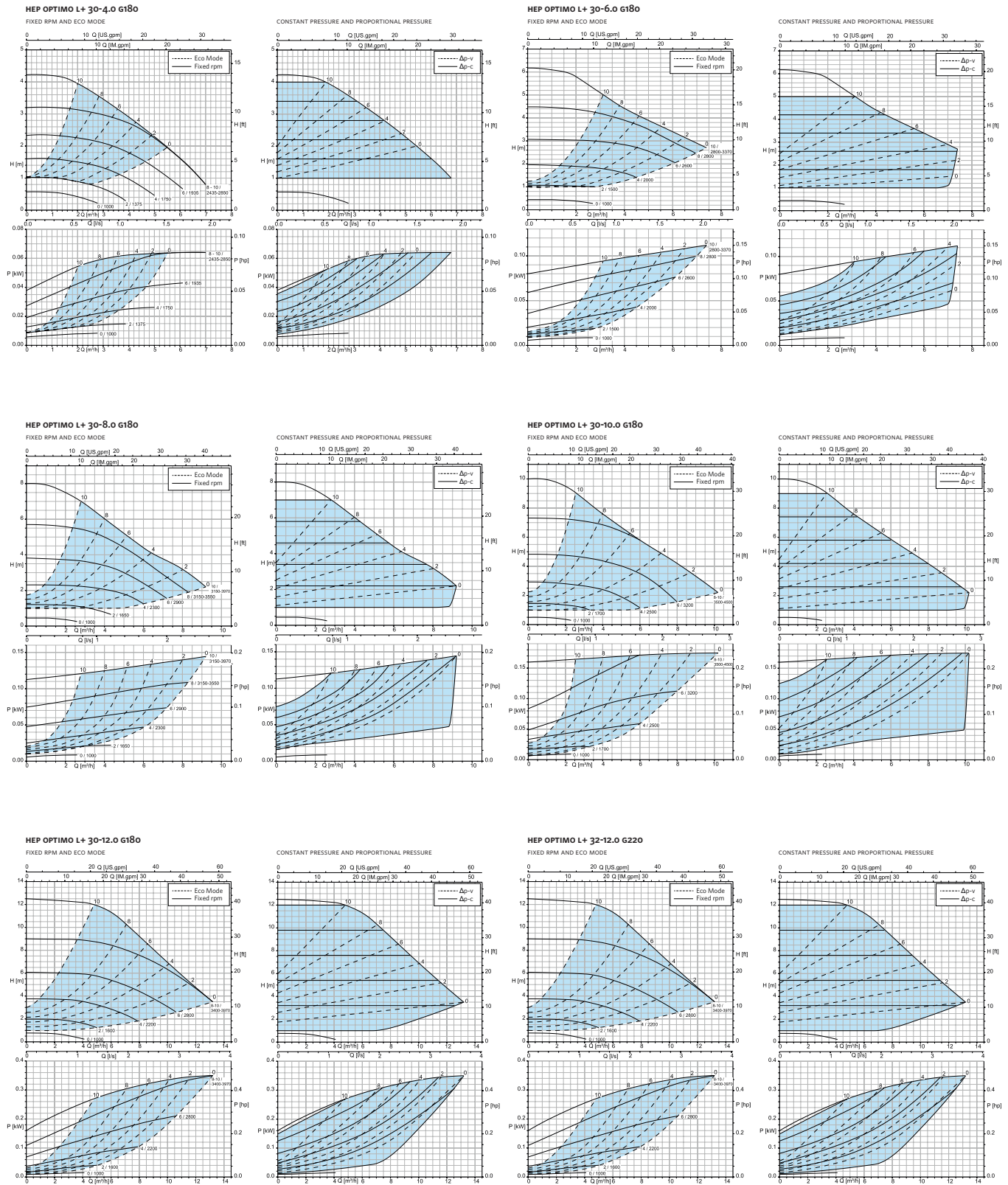

High efficiency pumps with LCD display, electronically controlled

HEP Optimo L+ series, H2 product group

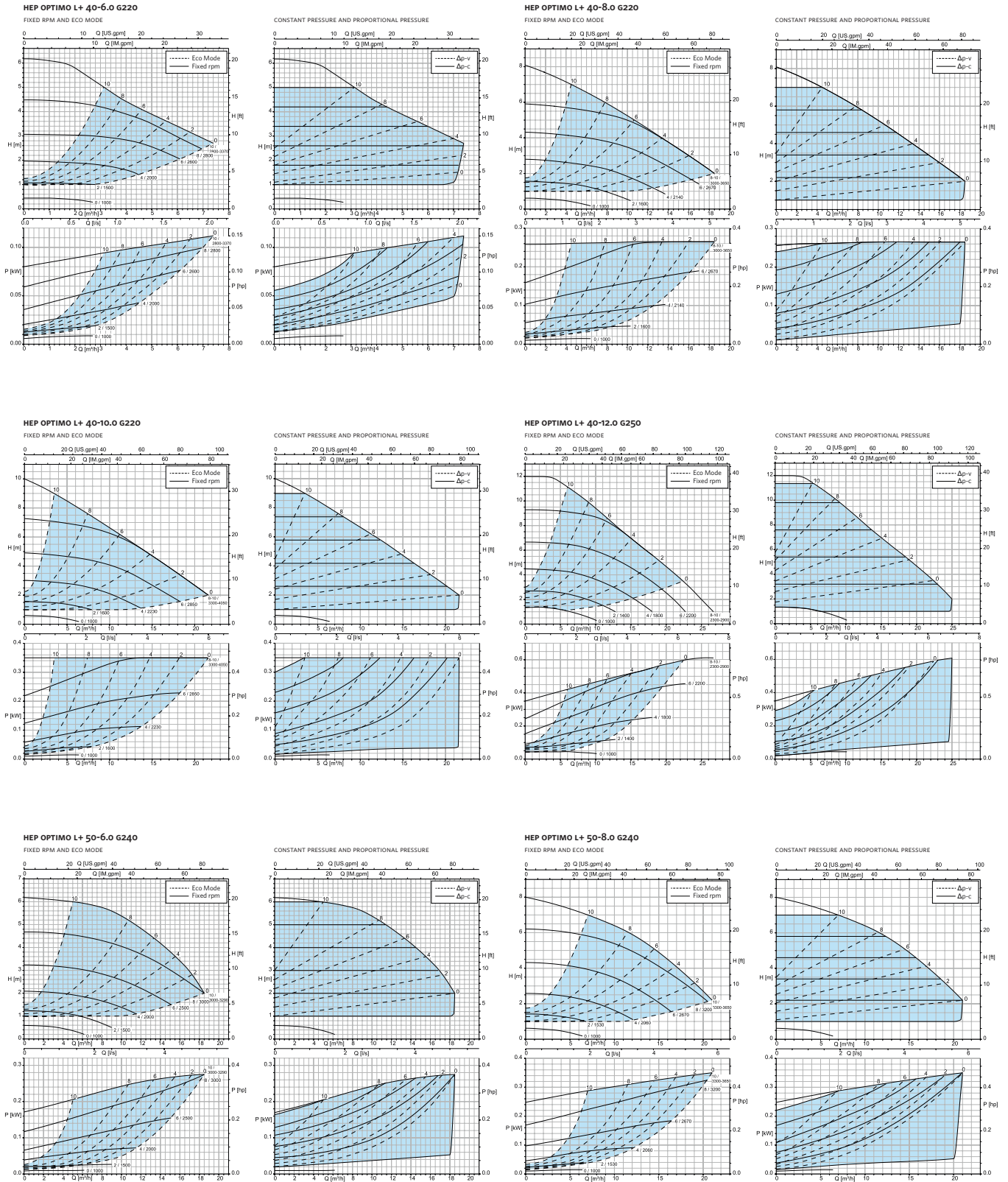

High efficiency pumps with LCD display, electronically controlled

HEP Optimo L+ series, H2 product group

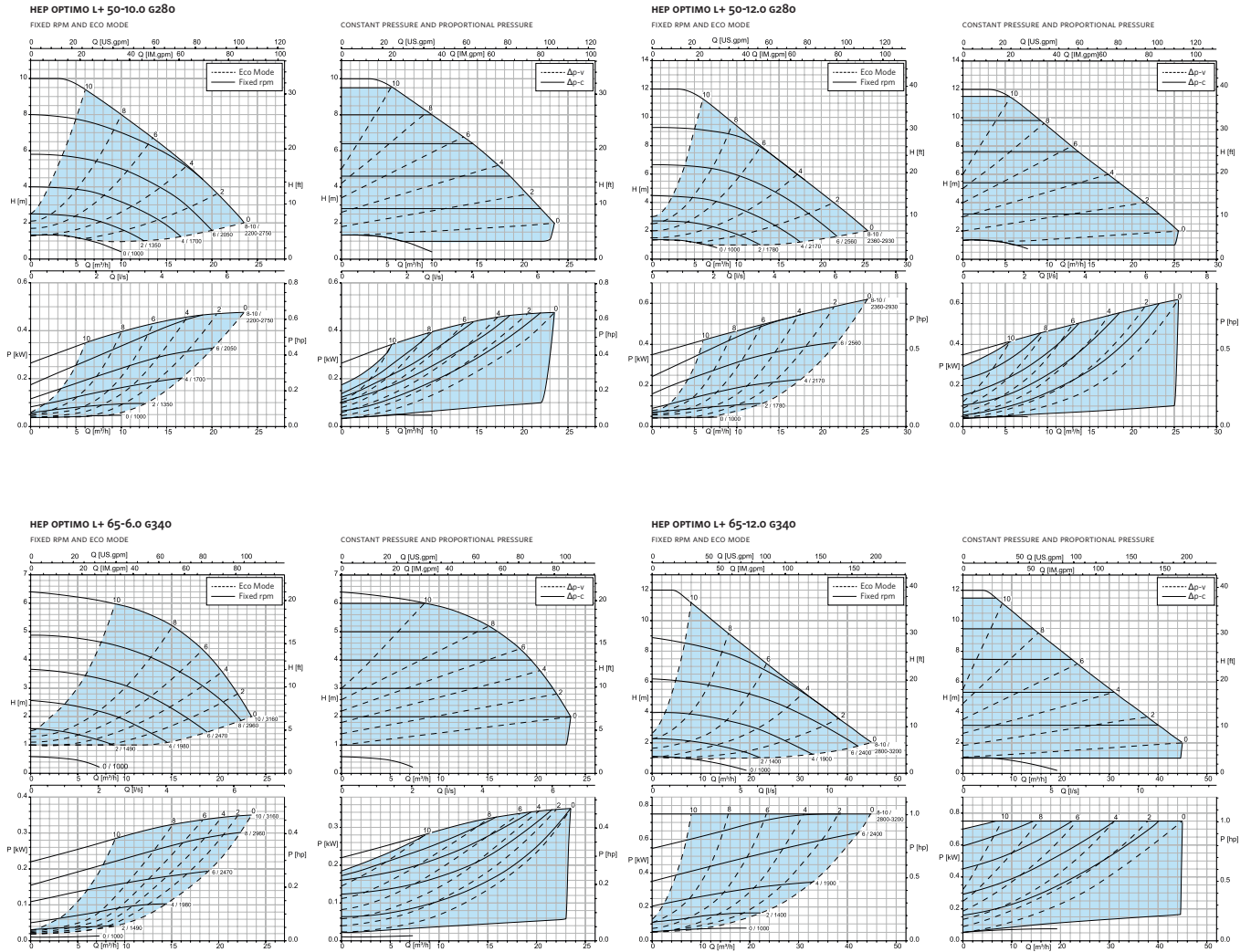

High efficiency pumps with LCD display, electronically controlled

HEP Optimo L+ series, H2 product group

DIMENSIONS (FLANGE DIMENSIONS IN MM)

COMBINATION FLANGES	PN 6			PN 10		
	ØD	ØK	N x D2	ØD	ØK	N x D2
DN 32	120	90	4 x Ø14	140	100	4 x Ø19
DN 40	130	100	4 x Ø14	150	110	4 x Ø19
DN 50	140	110	4 x Ø14	165	125	4 x Ø19
DN 65	160	130	4 x Ø14	185	145	4 x Ø19

DIMENSION ILLUSTRATION

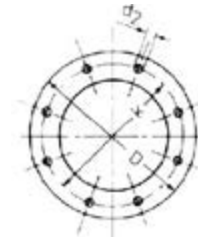

DIMENSIONS (CIRCULATOR DIMENSIONS IN MM)

TYPE	A (MM)	B (MM)	C (MM)	D (MM)	E (MM)	F (MM)
HEP OPTIMO L+ 25-6.0 G180	192	53	102	180	140	160
HEP OPTIMO L+ 25-8.0 G180	192	53	102	180	140	160
HEP OPTIMO L+ 25-10.0 G180	192	53	102	180	140	160
HEP OPTIMO L+ 30-6.0 G180	192	53	102	180	140	160
HEP OPTIMO L+ 30-8.0 G180	192	53	102	180	140	160
HEP OPTIMO L+ 30-10.0 G180	192	53	102	180	140	160
HEP OPTIMO L+ 30-12.0 G180	245	56	98	180	140	160
HEP OPTIMO L+ 32-12.0 G220	245	65	110	220	140	160
HEP OPTIMO L+ 40-6.0 G220	192	70	110	220	140	160
HEP OPTIMO L+ 40-8.0 G220	192	70	120	220	140	160
HEP OPTIMO L+ 40-10.0 G220	255	70	120	220	140	160
HEP OPTIMO L+ 40-12.0 G250	382	76	135	250	206	240
HEP OPTIMO L+ 50-6.0 G240	256	78	130	240	140	160
HEP OPTIMO L+ 50-8.0 G240	256	78	130	240	140	160
HEP OPTIMO L+ 50-10.0 G280	382	77	140	280	206	240
HEP OPTIMO L+ 50-12.0 G280	382	77	140	280	206	240
HEP OPTIMO L+ 65-6.0 G340	257	89	170	340	140	160
HEP OPTIMO L+ 65-12.0 G340	387	100	170	340	206	240

DIMENSION ILLUSTRATION (THREADED VERSION)

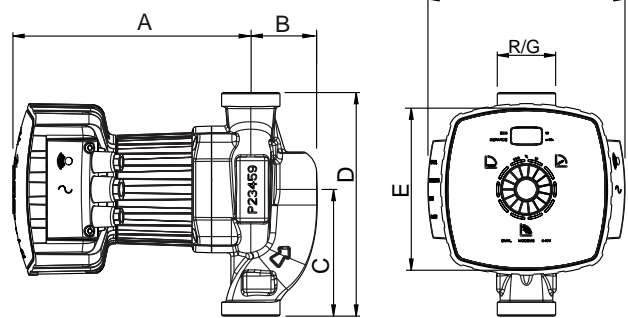

DIMENSION ILLUSTRATION (FLANGE VERSION)

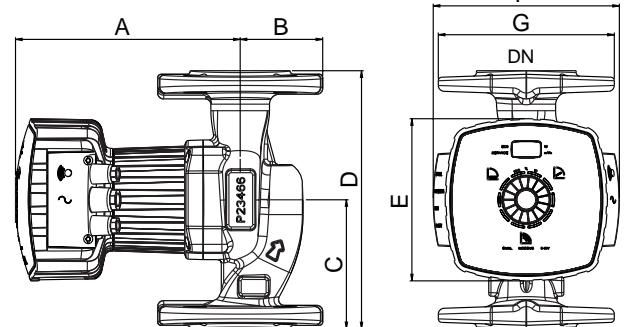

High efficiency pumps with LED display

AGE3 series, H2 product group



TECHNICAL DATA

Rate of flow:	Threaded: up to 9m ³ /h (2.5 l/s) Flanged: up to 83m ³ /h (23.0 l/s)
Pressure head:	6 m/8 m/10 m/12 m/18 m
Control range:	10-90W/10-180W/25-270W/25-480W/25-560W/ 25-1100W/38-1100W/20-1500W/45-1600W
Media temperature:	+2 °C to +110 °C
Installation length:	180 mm (threaded) 220, 250, 280, 340 and 360 mm (flanged)
Circulator connection:	1" and ½" (threaded), DN32, 40, 50, 65, 80 and 100 (flanged)
Protection class:	IP 44
Insulation class:	F
Nominal pressure:	6/10 bar (flanged) 10 bar (threaded)
EEl:	≤ 0.23

Control:

Internal:	<ul style="list-style-type: none"> Constant-pressure Δp_c or proportional-pressure Δp_v control Auto Mode with dynamic differential pressure setpoint adjustment Constant speed control with manual selection
External:	<ul style="list-style-type: none"> 0-10 V external speed control MODBUS or Ethernet speed control

PRODUCT FEATURES

- LED display
- manual start-up feature
- smooth running
- very low energy consumption
- collective fault signal
- convenient operation
- front facing integrated terminal box
- automatic adjustment to pressure conditions

USE

The Armstrong AGE3 is a high-efficiency, variable speed wet rotor Circulator with ECM technology and permanent magnet rotor. It offers operating flexibility and an industry-leading feature set to support a wide range of heating and cooling applications.

MAIN AREAS OF USE

- heating
- cooling
- plumbing applications

CONTROLS FUNCTION

You can make adjustments with the integrated control keys at the front. The LED display shows the total electrical input power as a numeric value in [W] watts. Different icons at the top of the display show the function, setting and the modes of operation.

MATERIALS

Component	Material	Material no.
Pump housing	Cast Iron	
Impeller	PES	PES GF 30
Shaft	Stainless steel	AISI 420
Bearing	Graphite	
Bearing plate	Stainless steel	
Can	Stainless steel	AISI 316

TEMPERATURE RANGE

Ambient temperature:	0 °C to +40 °C
Temperature class:	TF 110
Media temperature:	+2 °C to +110 °C

AMBIENT TEMPERATURE

Ambient temp.	Media temp. min.	Media temp. max.
Up to 25 °C	-10 °C	110 °C
30 °C	-10 °C	100 °C
35 °C	-10 °C	90 °C
40 °C	-10 °C	80 °C

MOTOR PROTECTION

External motor protection is not required.

MINIMUM INFLOW PRESSURE

Please determine the minimum inflow pressure for corresponding temperature from the following table.

Media temperature	< 80 °C	90 °C
Minimum inflow pressure	0.05 bar	0.28 bar

SOUND PRESSURE LEVEL

The sound pressure level is < 43 dB (A).

TECHNICAL DATA

TYPE	CONNECTION PIPE	THREADED CONNECTION	FLANGE	INSTALLATION LENGTH (MM)	VOLTAGE / FREQUENCY	P1 (W)	I _{max} (A)	NET-WEIGHT (KG)	PRODUCT NO.	EEL
AGE3 25-60	RP 1"	G1 ½"		180	230/1/50	10 ... 90	0,75	3,2	AGE3-25-60	≤ 0.21
AGE3 25-100	RP 1"	G1 ½"		180	230/1/50	10 ... 180	1,5	3,2	AGE3-25-100	≤ 0.21
AGE3 25-120	RP 1"	G1 ½"		180	230/1/50	10 ... 180	1,5	3,2	AGE3-25-120	≤ 0.21
AGE3 30-60	RP 1¼"	G2"		180	230/1/50	10 ... 90	0,75	3,5	AGE3-30-60	≤ 0.21
AGE3 30-100	RP 1¼"	G2"		180	230/1/50	10 ... 180	1,5	3,5	AGE3-30-100	≤ 0.21
AGE3 30-120	RP 1¼"	G2"		180	230/1/50	10 ... 180	1,5	3,5	AGE3-30-120	≤ 0.21
AGE3 32-120	DN 32		DN 32	220	230/1/50	25 ... 480	1,5	10	AGE3-32-120	≤ 0.21
AGE3 40-80	DN 40		DN 40	220	230/1/50	25 ... 270	3,8	10,2	AGE3-40-80	≤ 0.21
AGE3 40-120	DN 40		DN 40	220	230/1/50	25 ... 480	3,8	10	AGE3-40-120	≤ 0.21
AGE3 40-180	DN 40		DN 40	220	230/1/50	25 ... 1100	3,8	20	AGE3-40-180	≤ 0.23
AGE3 50-80	DN 50		DN 50	280	230/1/50	25 ... 270	3,8	11	AGE3-50-80	≤ 0.22
AGE3 50-120	DN 50		DN 50	280	230/1/50	25 ... 560	3,8	13	AGE3-50-120	≤ 0.21
AGE3 50-180	DN 50		DN 50	280	230/1/50	25 ... 1100	4,8	30	AGE3-50-180	≤ 0.23
AGE3 65-80	DN 65		DN 65	340	230/1/50	25 ... 560	3,8	13	AGE3-65-80	≤ 0.22
AGE3 65-120	DN 65		DN 65	340	230/1/50	38 ... 1100	4,8	34	AGE3-65-120	≤ 0.23
AGE3 65-180	DN 65		DN 65	340	230/1/50	20 ... 1500	6,7	39	AGE3-65-180	≤ 0.23
AGE3 80-80	DN 80		DN 80	360	230/1/50	45 ... 1600	6,9	40	AGE3-80-80	≤ 0.23
AGE3 80-120	DN 80		DN 80	360	230/1/50	45 ... 1600	6,9	40,8	AGE3-80-120	≤ 0.23
AGE3 100-120	DN 100		DN 100	360	230/1/50	45 ... 1600	6,9	47	AGE3-100-120	≤ 0.23

PERFORMANCE CURVES

AGE3 25-60 + AGE3 30-60

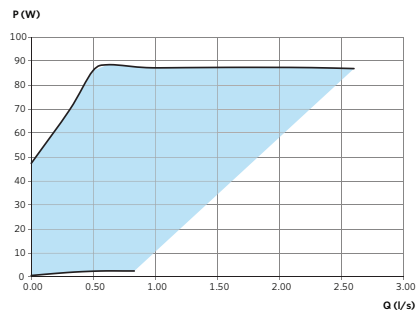
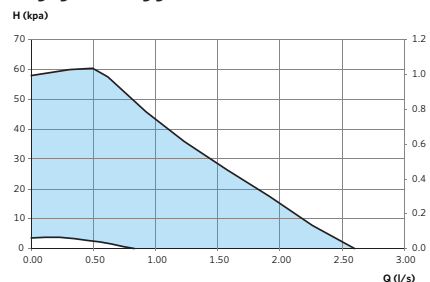

AGE3 25-100 + AGE3 30-100

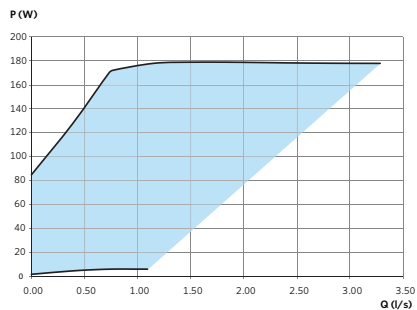
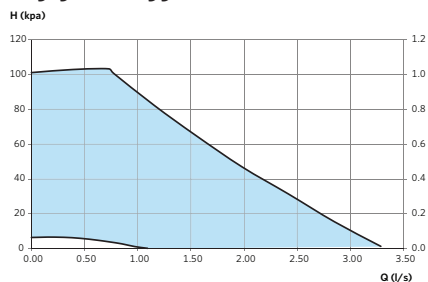

AGE3 25-120 + AGE3 30-120

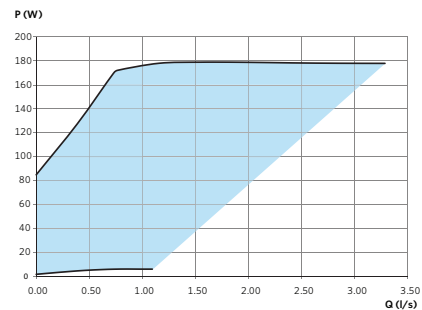
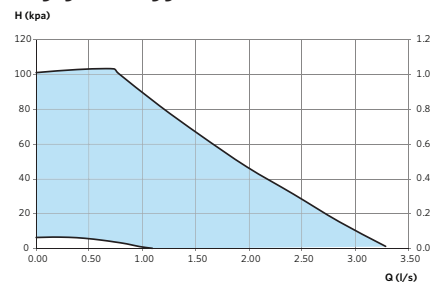

High efficiency pumps with LED display

AGE3 series, H2 product group

AGE3 32-120

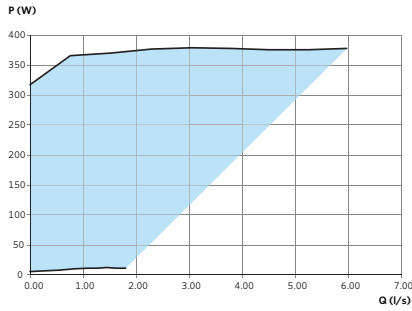
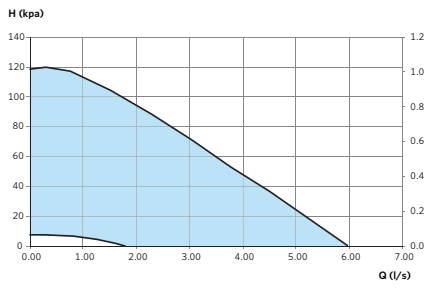

AGE3 40-80

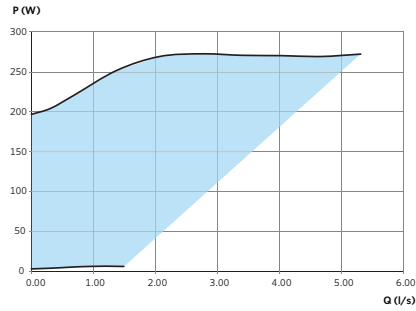
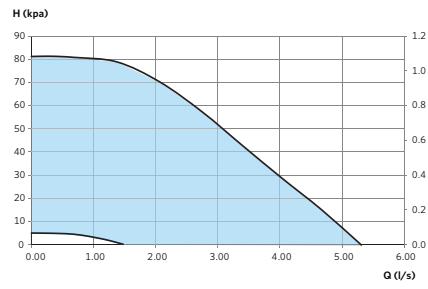

AGE3 40-120

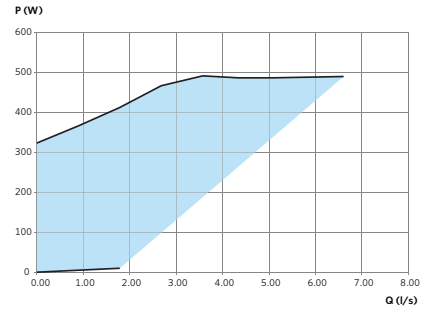
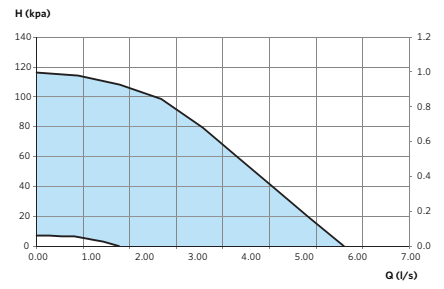

AGE3 40-180

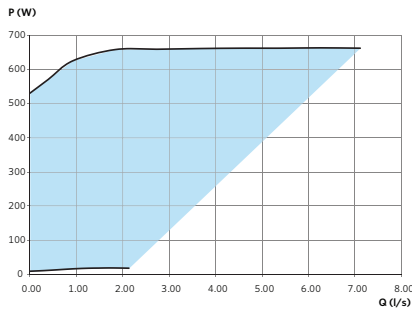
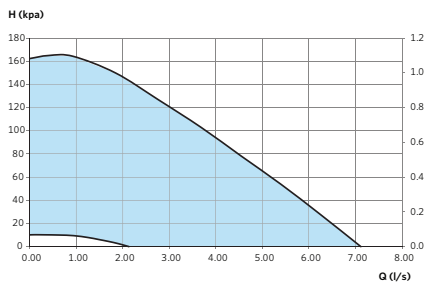

AGE3 50-80

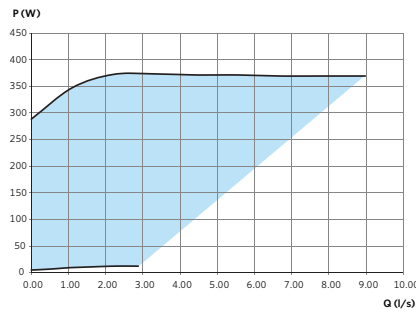
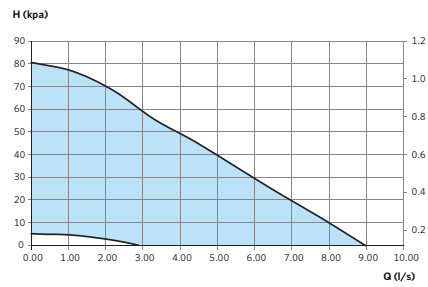

AGE3 50-120

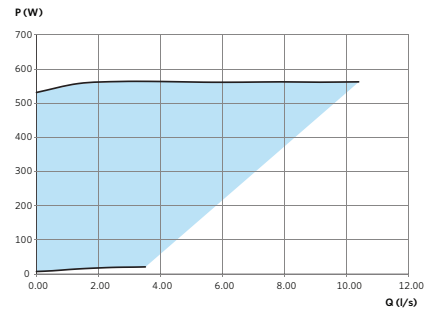
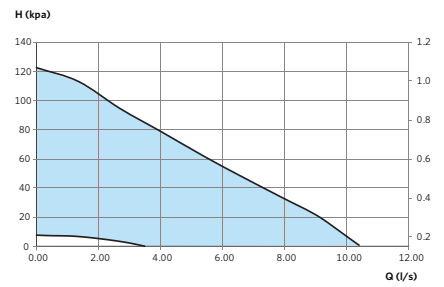

AGE3 50-180

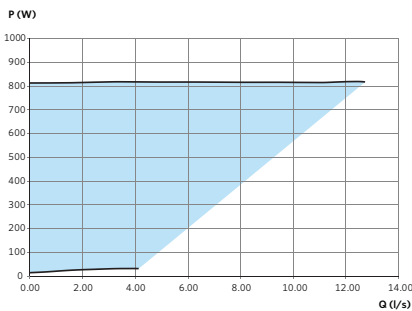
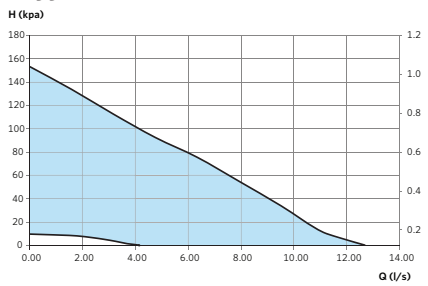

AGE3 65-80

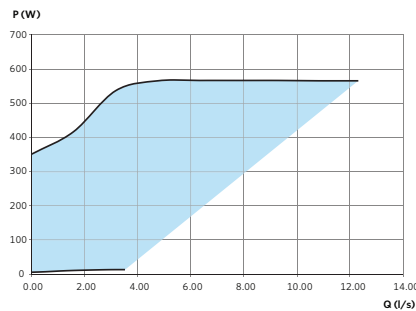
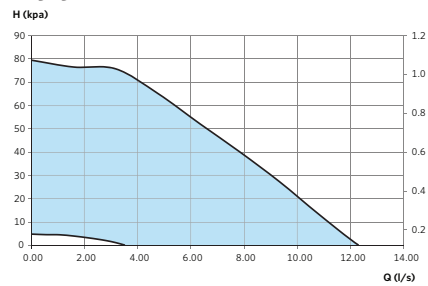

AGE3 65-120

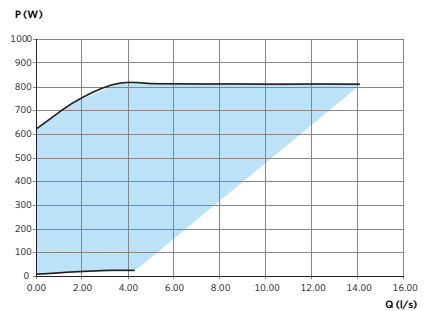
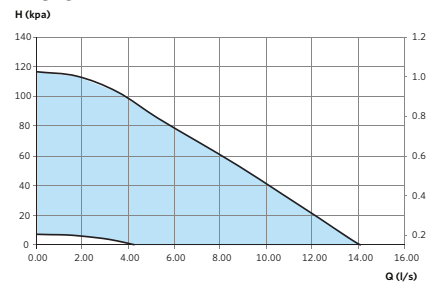

AGE3 65-180

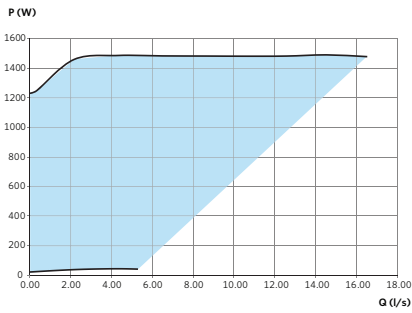
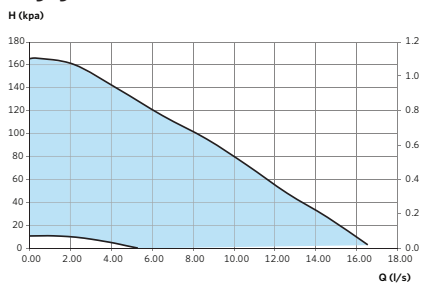

AGE3 80-80

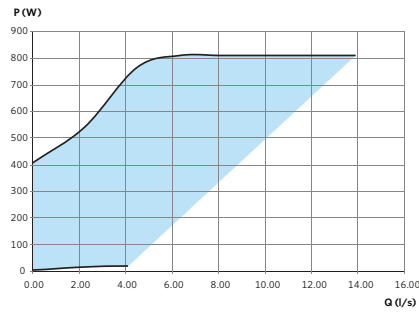
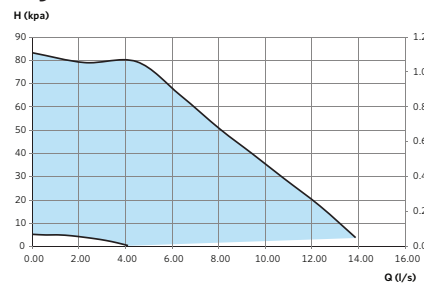

AGE3 80-120

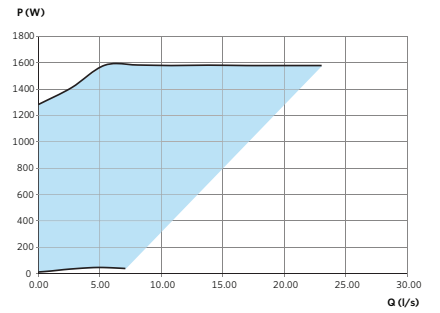
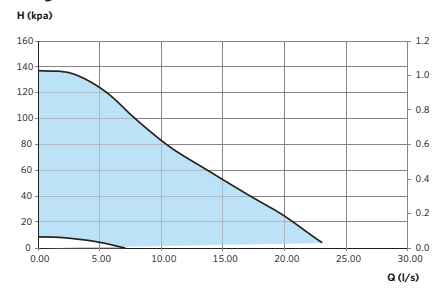

AGE3 100-120

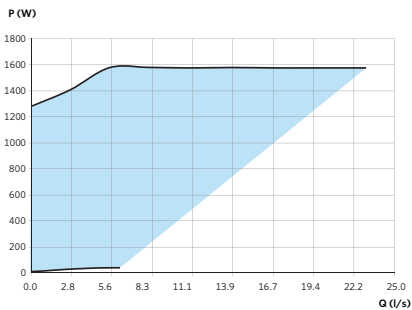
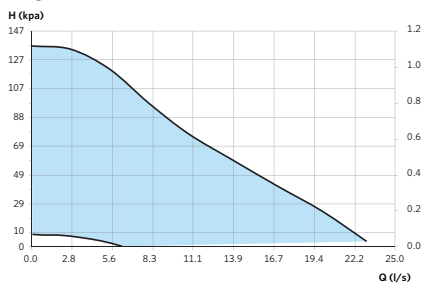

High efficiency pumps with LED display

AGE3 series, H2 product group

DIMENSIONS

TYPE	A (MM)	B (MM)	C (MM)	D (MM)	E (MM)
AGE3 25-60	180	95	180	58.5	58.5
AGE3 25-100	180	95	180	58.5	58.5
AGE3 25-120	180	95	180	58.5	58.5
AGE3 30-60	180	95	180	58.5	58.5
AGE3 30-100	180	95	180	58.5	58.5
AGE3 30-120	180	95	180	58.5	58.5
AGE3 32-120	297	65	220	75	75
AGE3 40-80	260	65	220	72	72
AGE3 40-120	297	65	250	75	75
AGE3 40-180	357	65	250	90	90
AGE3 50-80	333	72	280	75	92
AGE3 50-120	333	72	280	75	92
AGE3 50-180	343	72	280	90	92
AGE3 65-80	343	75	340	83	103
AGE3 65-120	354	75	340	90	103
AGE3 65-180	403	80	340	95	127
AGE3 80-80	364	93	360	98	123
AGE3 80-120	403	100	360	105	125
AGE3 100-120	403	110	360	105	125

DIMENSION ILLUSTRATION (THREADED VERSION)

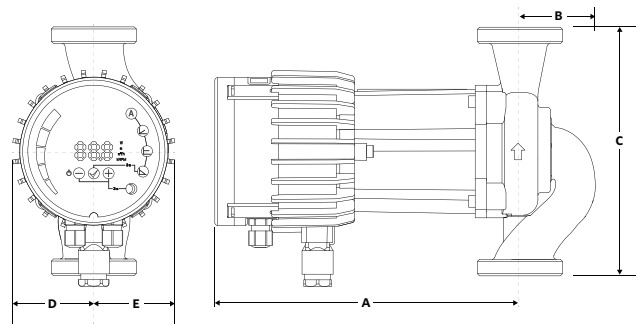

DIMENSION ILLUSTRATION (FLANGE VERSION)

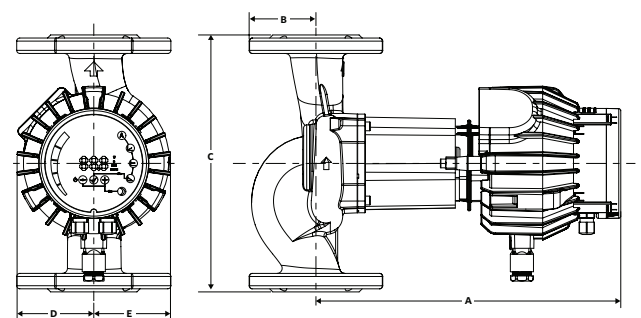

High efficiency pumps with LED display and twin pump single casing

AGE3 D series, H2 product group



TECHNICAL DATA

Rate of flow:	Threaded: up to 12m ³ /h (3.3 l/s) Flanged: up to 83m ³ /h (23.0 l/s)
Pressure head:	6 m/8 m/10 m/12 m/18 m
Control range:	10-90W/10-180W/25-270W/25-480W/25-560W/ 25-1100W/38-1100W/20-1500W/45-1600W
Media temperature:	+2 °C to +110 °C
Installation length:	180, 220, 250, 280, 340 and 360 mm
Circulator connection:	2" (threaded) DN32, 40, 50, 65, 80 (flanged)
Protection class:	IP 44
Insulation class:	F
Nominal pressure:	6/10 bar (flanged) 10 bar (threaded)
EEL:	≤ 0.23

Control:

Internal:	<ul style="list-style-type: none"> Constant-pressure Δp or proportional-pressure Δp control Auto Mode with dynamic differential pressure setpoint adjustment Constant speed control with manual selection
External:	<ul style="list-style-type: none"> 0-10 V external speed control MODBUS or Ethernet speed control

PRODUCT FEATURES

- LED display
- manual start-up feature
- smooth running
- very low energy consumption
- collective fault signal
- convenient operation
- front facing integrated terminal box
- automatic adjustment to pressure conditions

USE

The Armstrong AGE3 D is a twin casing circulator for duty/standby operation. It is a high-efficiency, variable speed wet rotor Circulator with ECM technology and permanent magnet rotor. It offers operating flexibility and an industry-leading feature set to support a wide range of heating and cooling applications.

MAIN AREAS OF USE

- heating
- cooling
- plumbing applications

CONTROLS FUNCTION

You can make adjustments with the integrated control keys at the front. The LED display shows the total electrical input power as a numeric value in [W] watts. Different icons at the top of the display show the function, setting and the modes of operation.

MATERIALS

Component	Material	Material no.
Pump housing	Cast Iron	
Impeller	PES	PES GF 30
Shaft	Stainless steel	AISI 420
Bearing	Graphite	
Bearing plate	Stainless steel	
Can	Stainless steel	AISI 316

TEMPERATURE RANGE

Ambient temperature:	0 °C to +40 °C
Temperature class:	TF 110
Media temperature:	+2 °C to +110 °C

AMBIENT TEMPERATURE

Ambient temp.	Media temp. min.	Media temp. max.
Up to 25 °C	-10 °C	110 °C
30 °C	-10 °C	100 °C
35 °C	-10 °C	90 °C
40 °C	-10 °C	80 °C

MOTOR PROTECTION

External motor protection is not required.

MINIMUM INFLOW PRESSURE

Please determine the minimum inflow pressure for corresponding temperature from the following table.

Media temperature	< 80 °C	90 °C
Minimum inflow pressure	0.05 bar	0.28 bar

SOUND PRESSURE LEVEL

The sound pressure level is < 43 dB (A).

High efficiency pumps with LED display and twin pump single casing

AGE3 D series, H2 product group

TECHNICAL DATA

TYPE	CONNECTION PIPE	THREADED CONNECTION	FLANGE	INSTALLATION LENGTH (MM)	VOLTAGE / FREQUENCY	P1 (W)	I _{max} (A)	NET-WEIGHT (KG)	PRODUCT NO.	EEL
AGE3 D 30-60	RP 1¼"	G2"		180	230/1/50	10 ... 90	0,75	8,2	AGE3D-30-60	≤ 0.21
AGE3 D 30-100	RP 1¼"	G2"		180	230/1/50	10 ... 180	1,5	8,6	AGE3D-30-100	≤ 0.21
AGE3 D 32-120	DN 32		DN 32	220	230/1/50	25 ... 480	1,5	22	AGE3D-32-120	≤ 0.22
AGE3 D 40-80	DN 40		DN 40	220	230/1/50	25 ... 270	3,8	21	AGE3D-40-80	≤ 0.21
AGE3 D 40-120	DN 40		DN 40	220	230/1/50	25 ... 480	3,8	22	AGE3D-40-120	≤ 0.21
AGE3 D 40-180	DN 40		DN 40	220	230/1/50	25 ... 1100	3,8	42	AGE3D-40-180	≤ 0.23
AGE3 D 50-80	DN 50		DN 50	280	230/1/50	25 ... 270	3,8	24	AGE3D-50-80	≤ 0.22
AGE3 D 50-120	DN 50		DN 50	280	230/1/50	25 ... 480	3,8	28	AGE3D-50-120	≤ 0.21
AGE3 D 50-180	DN 50		DN 50	280	230/1/50	25 ... 1100	4,8	62	AGE3D-50-180	≤ 0.23
AGE3 D 65-80	DN 65		DN 65	340	230/1/50	25 ... 560	3,8	28	AGE3D-65-80	≤ 0.22
AGE3 D 65-120	DN 65		DN 65	340	230/1/50	38 ... 1100	4,8	70	AGE3D-65-120	≤ 0.23
AGE3 D 65-180	DN 65		DN 65	340	230/1/50	20 ... 1500	6,7	80	AGE3D-65-180	≤ 0.23
AGE3 D 80-80	DN 80		DN 80	360	230/1/50	45 ... 1600	6,9	78	AGE3D-80-80	≤ 0.23
AGE3 D 80-120	DN 80		DN 80	360	230/1/50	45 ... 1600	6,9	78	AGE3D-80-120	≤ 0.23

PERFORMANCE CURVES

AGE3 D 30-60

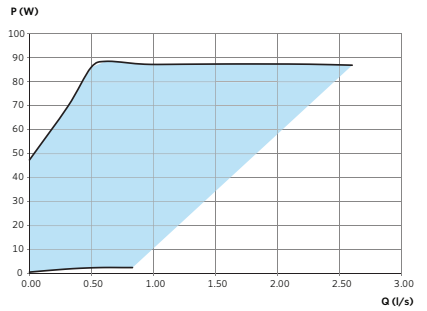
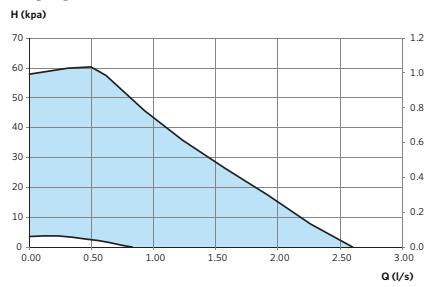

AGE3 D 30-100

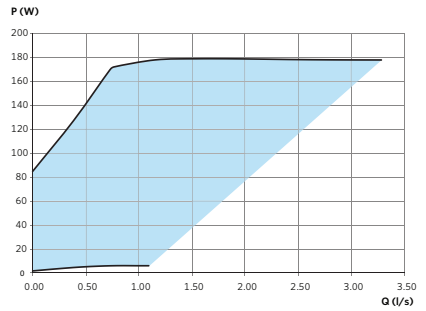
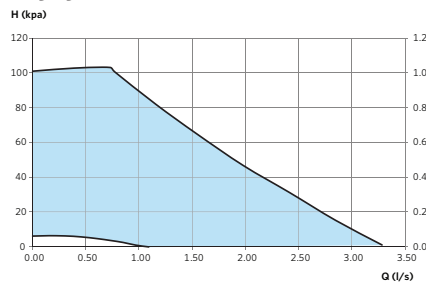

AGE3 D 32-120

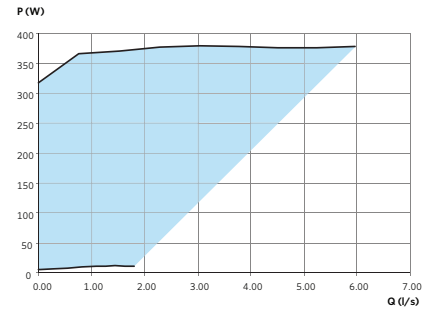
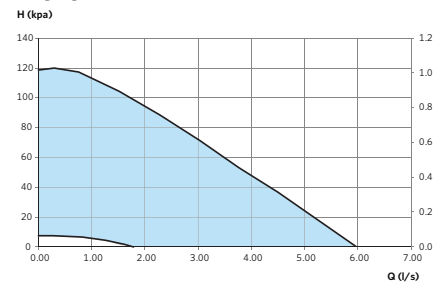

AGE3 D 40-80

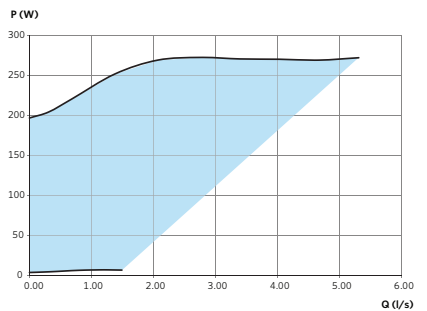
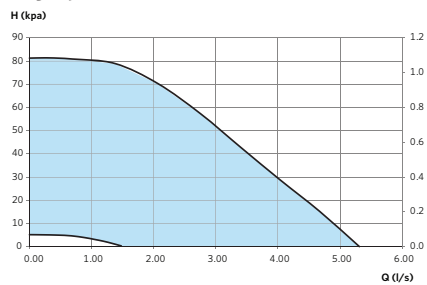

AGE3 D 40-120

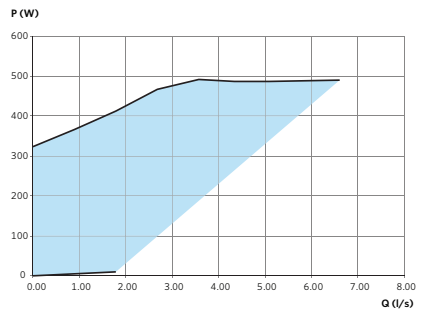
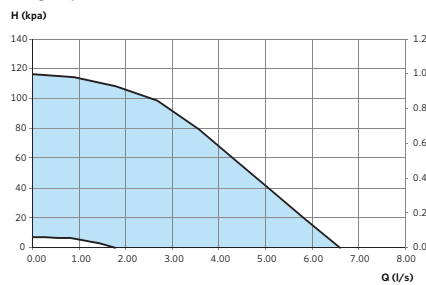

AGE3 D 40-180

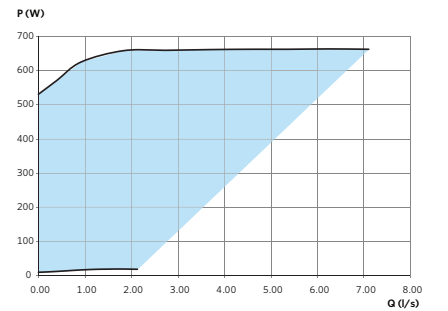
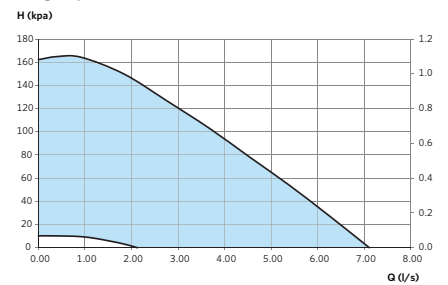

High efficiency pumps with LED display and twin pump single casing

AGE3 D series, H2 product group

AGE3 D 50-80

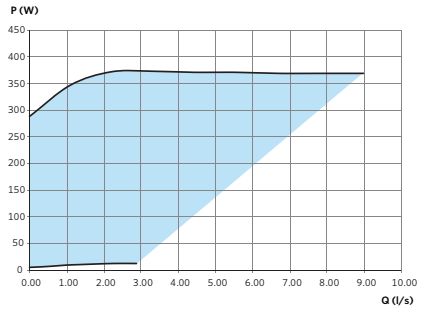
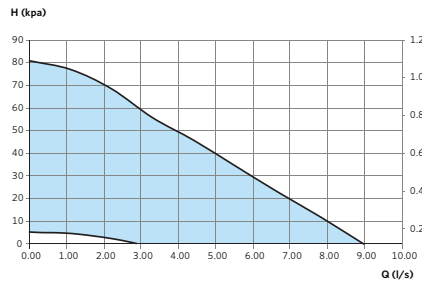

AGE3 D 50-120

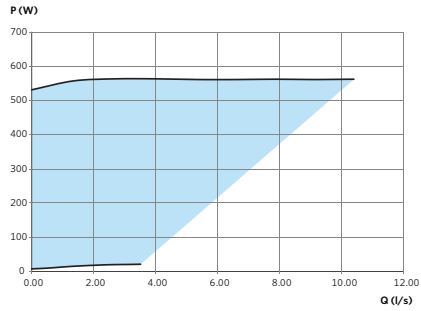
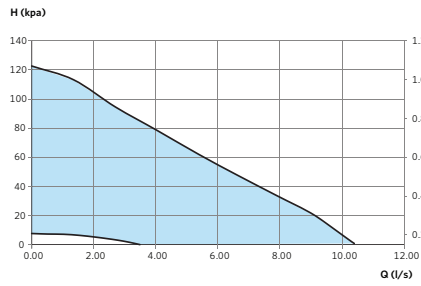

AGE3 D 50-180

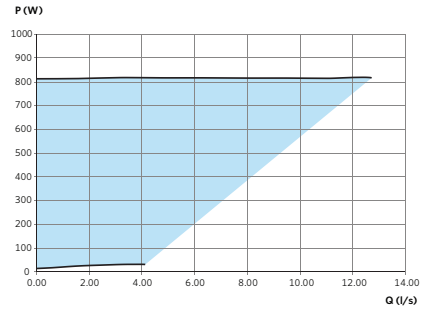
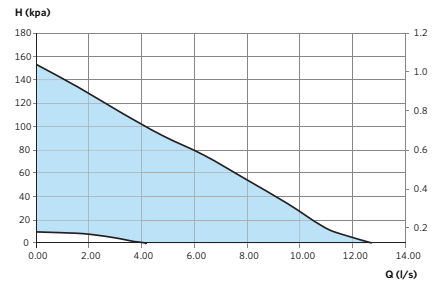

AGE3 D 65-80

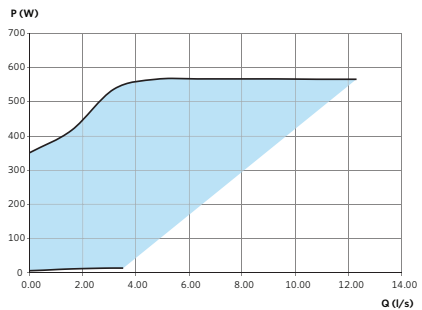
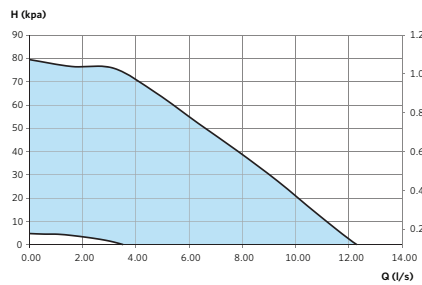

AGE3 D 65-120

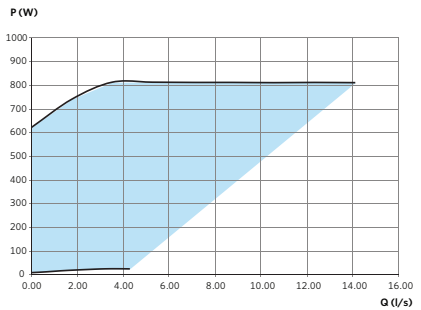
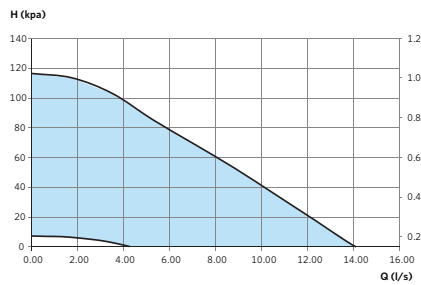

AGE3 D 65-180

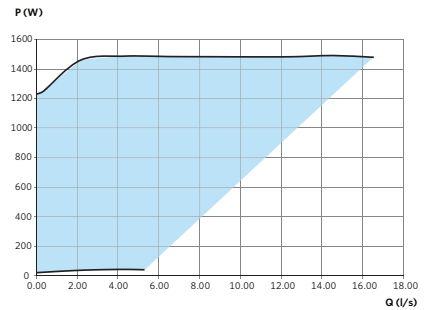
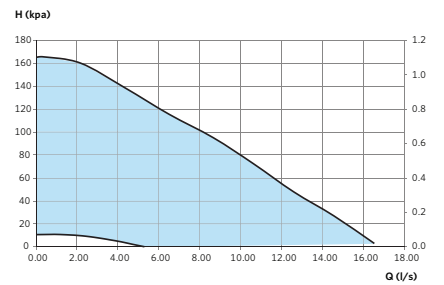

AGE3 D 80-80

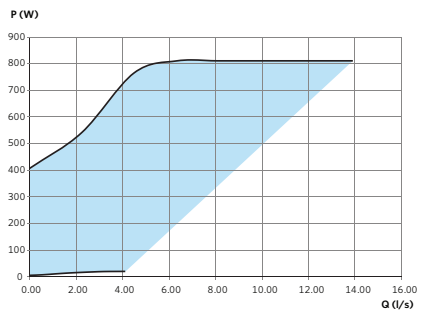
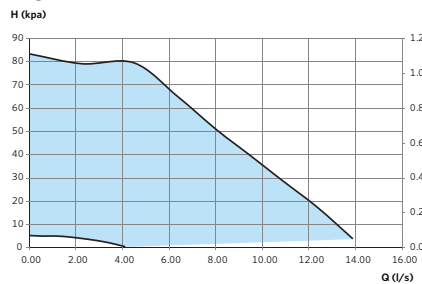

AGE3 D 80-120

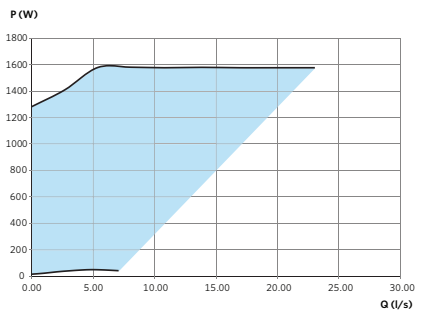
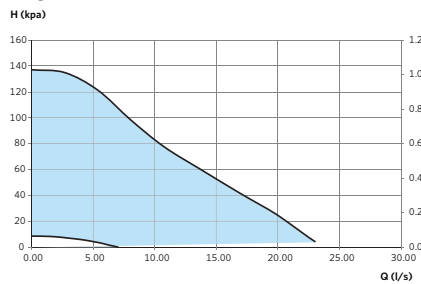

High efficiency pumps with LED display and twin pump single casing

AGE3 D series, H2 product group

DIMENSIONS (CIRCULATOR DIMENSIONS IN MM)

TYPE	A (MM)	B (MM)	C (MM)	D (MM)	E (MM)
AGE3 D 30-60	222	56	180	149	149
AGE3 D 30-100	222	56	180	149	149
AGE3 D 32-120	297	65	220	185	186
AGE3 D 40-80	260	65	220	185	186
AGE3 D 40-120	297	65	250	185	186
AGE3 D 40-180	357	65	250	200	200
AGE3 D 50-80	333	72	280	200	200
AGE3 D 50-120	333	72	280	200	200
AGE3 D 50-180	343	72	280	200	203
AGE3 D 65-80	343	75	340	216	226
AGE3 D 65-120	352	75	340	216	226
AGE3 D 65-180	403	80	340	216	236
AGE3 D 80-80	364	93	360	241	253
AGE3 D 80-120	403	100	360	211	251

DIMENSION ILLUSTRATION (THREADED VERSION)

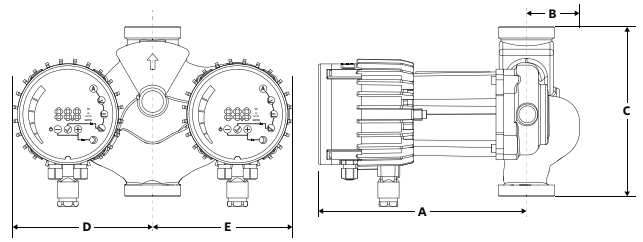

DIMENSION ILLUSTRATION (FLANGE VERSION)

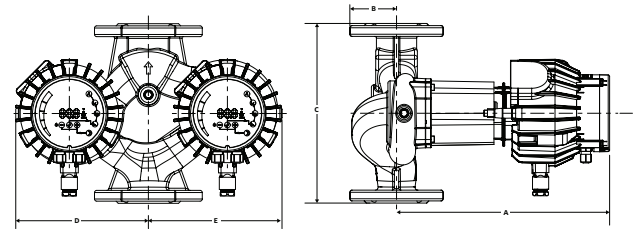

Standard circulation pumps for drinking water with stainless steel housing

BUPA (N) series, T3 product group



TECHNICAL DATA

Rate of flow:	up to 4.0 m ³ /h
Pressure head:	up to 6 m
Media temperature:	+2 °C to +110 °C
Installation length:	130, 150 and 180 mm
Threaded connection:	1", 1¼" and 1½"
Protection class:	IP 44
Insulation class:	H
Nominal pressure:	PN 10
Control:	3-step switch with manual speed selection

PRODUCT FEATURES

- manual start-up feature
- space-saving axially integrated terminal box

USE

The BUPA (N) series circulation pumps are wet rotor circulators designed for use in drinking water systems with constant or weakly variable flow rates. They feature a corrosion-resistant pump housing in stainless steel and are thus suitable for use in drinking water circulation systems.

MATERIALS

Component	Material	Material no.
Pump housing	Stainless steel	1.4308
Impeller	PSU - GF 20	
Shaft	Ceramic	
Bearing	Ceramic	
Bearing plate	Stainless steel	1.4301
Can	Stainless steel	1.4301

TEMPERATURE RANGE

Ambient temperature:	0 °C to +40 °C
Temperature class:	TF 110
Media temperature:	+2 °C to +110 °C

AMBIENT TEMPERATURE

To avoid condensation forming in the terminal box and stator, the media temperature must always be the same or higher than the ambient temperature.

Ambient temp.	Media temp. min.	Media temp. max.
0	2	110
10	10	110
20	20	110
30	30	110
35	35	110
40	40	110

MOTOR PROTECTION

External motor protection is not required.

SPEED SWITCHING

The respective speed is set via a rotary switch integrated in the axial terminal box.

MINIMUM INFLOW PRESSURE

Please determine the minimum inflow pressure for corresponding temperature from the following table.

Media temperature	< 85 °C	90 °C	110 °C
Minimum inflow pressure	0.05 bar	0.3 bar	1.10 bar

SOUND PRESSURE LEVEL

The sound pressure level is < 45 dB (A).

FLOW MEDIA

Only for drinking water up to a temperature of 65 °C and a max. degree of hardness of 14 °dH (temporary hardness).

Standard circulation pumps for drinking water with stainless steel housing

BUPA (N) series, T3 product group

TECHNICAL DATA

TYPE	CONNECTION PIPE	THREADED CONNECTION	INSTALLATION LENGTH (MM)	VOLTAGE / FREQUENCY	P1 (W)	I _{MAX} (A)	NET-WEIGHT (KG)	PRODUCT NO.
BUPA 25-2.5 N180	1"	1½"	180	230 V 50/60 HZ	27 ... 35	0,15	2,4	0353-30203-72
BUPA 25-4.0 N180	1"	1½"	180	230 V 50/60 HZ	33 ... 44	0,19	2,4	0353-30204-72
BUPA 25-6.0 N180	1"	1½"	180	230 V 50/60 HZ	43 ... 80	0,34	2,7	0353-30206-72
BUPA 15-2.5 N130	½"	1"	130	230 V 50/60 HZ	27 ... 35	0,15	2,0	0351-30003-72
BUPA 15-4.0 N130	½"	1"	130	230 V 50/60 HZ	33 ... 44	0,19	2,0	0351-30004-72
BUPA 15-6.0 N130	½"	1"	130	230 V 50/60 HZ	43 ... 80	0,34	2,3	0351-30006-72
BUPA 20-2.5 N150	¾"	1¼"	150	230 V 50/60 HZ	27 ... 35	0,15	2,1	0352-30103-72
BUPA 20-4.0 N150	¾"	1¼"	150	230 V 50/60 HZ	33 ... 44	0,19	2,1	0352-30104-72
BUPA 20-6.0 N150	¾"	1¼"	150	230 V 50/60 HZ	43 ... 80	0,34	2,4	0352-30106-72
BUPA 25-2.5 N130	1"	1½"	130	230 V 50/60 HZ	27 ... 35	0,15	2,2	0353-30003-72
BUPA 25-4.0 N130	1"	1½"	130	230 V 50/60 HZ	33 ... 44	0,19	2,2	0353-30004-72
BUPA 25-6.0 N130	1"	1½"	130	230 V 50/60 HZ	43 ... 80	0,34	2,5	0353-30006-72

PERFORMANCE CURVES

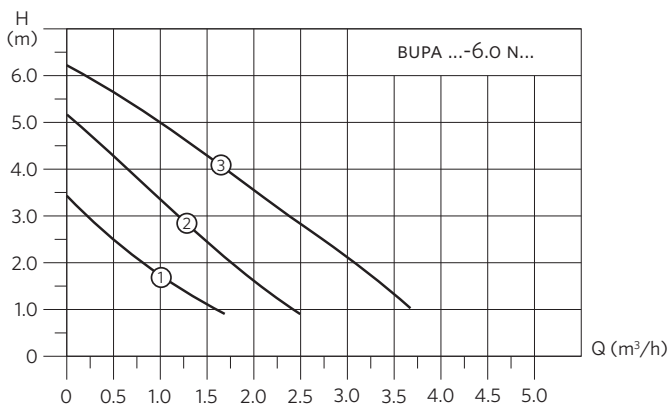
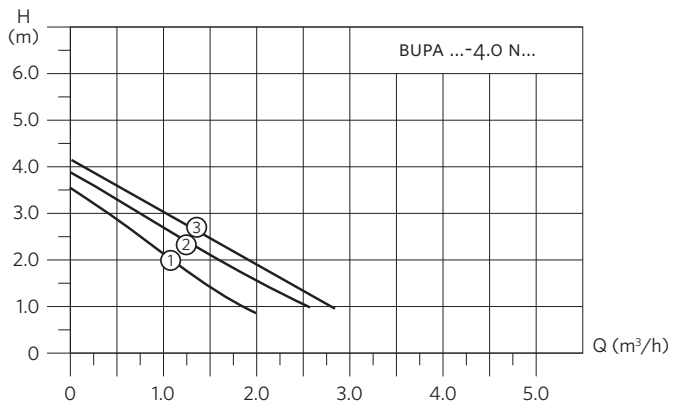
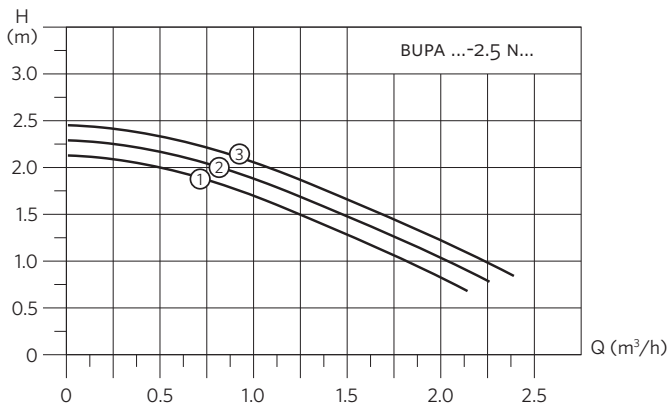

DIMENSIONS

TYPE	L1 (MM)	L2 (MM)	L3 (MM)	L4 (MM)
BUPA (N)	130/150/180	98	108	145

DIMENSION ILLUSTRATION

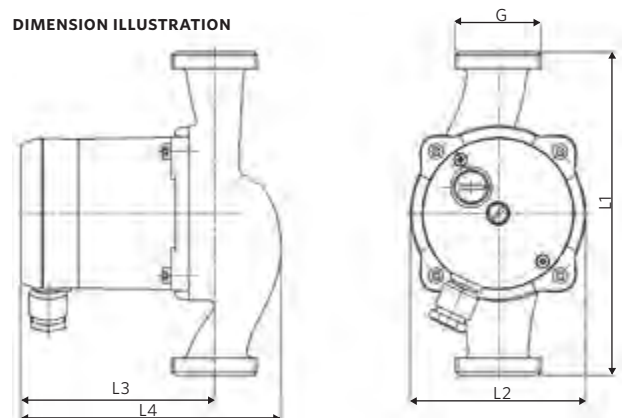

High efficiency pumps with stainless steel housing, electronically controlled

HEP Optimo Basic (N) series, T1 product group



5
YEAR
WARRANTY
★★★★★

ERP
2015⁺

BAFA
GEFÖRDERT

BEST
in class

TECHNICAL DATA

Rate of flow:	up to 3.6 m ³ /h
Pressure head:	4 m/6 m
Control range:	4-20 W/5-37 W
Media temperature:	+2 °C to +110 °C
Installation length:	130, 150 and 180 mm
Threaded connection:	1", 1½" and 2"
Protection class:	IP 42
Insulation class:	F
Nominal pressure:	PN 10
Control:	Δpc + Δpv + fixed rpm
EEL:	≤ 0.17 HEP Optimo Basic XX-4.0 NXXX ≤ 0.18 HEP Optimo Basic XX-6.0 NXXX

PRODUCT FEATURES

- manual start-up feature
- smooth running
- very low energy consumption
- integrated night economy feature
- air-vent screw
- convenient operation
- space-saving axially integrated terminal box
- automatic adjustment to pressure conditions
- stainless steel pump housing
- pre-mounted cable (1 m)
- compact design

USE

The electronically controlled HEP Optimo (N) high efficiency wet rotorcirculators with LED display and permanent magnet technology are redesigned for use in heating and solar systems as well as drinking water systems with variable or constant rate of flow.

MODE OF OPERATION ΔP CONTROL IN HEATING SYSTEMS

When thermostatic valves in systems with a long main supply heating pipe (likely for radiator systems) close, the total flow drops. This results in lower pipe resistance in this main pipe, which means the pump has to create lower head. Using proportional pressure mode PP (⚡) is the preferred setting for such heating systems, as here the pump decreases head at lower flow.

If the main supply heating pipe has not to be taken into consideration, because it is short or has its own pump (likely for underfloor heating systems with in mixing units integrated pumps or drinking water systems), the best mode to use is constant pressure mode CP (⊞). In such heating systems, it is important always to have constant pressure for the radiators or ufh-circuits, as the pressure loss in the main pipe is not considered and all other consumers are installed in parallel, which does not influence the maximum pressure loss.

CONTROL MODES FOR USE IN SOLAR SYSTEMS

As a rule, solar systems are designed for constant flow. High differential pressure at low flow is required. The fixed speed mode (⚡) is recommended for this. With this setting, the pump generates the highest possible differential pressure.

In the case of solar systems with a variable flow rate, the setting „Constant pressure“ (⊞) can alternatively be selected. Here, the differential pressure is kept constant regardless of the respective hydraulic situation of the solar system.

The „Proportional pressure“ (⚡) control mode may only be selected if the solar pump is used in a heating system with thermostatic valves.

Important: High efficiency pumps with electronically commutated motor (ECM) and integrated automatic control - such as the HEP Optimo - cannot be operated via external controls, which control pumps via wave packet or leading edge control. The Armstrong series HEP BB2 is recommended for such cases.

MAIN AREAS OF USE

- drinking water systems with fixed speed mode (Display indicates ⚡)

MATERIALS

Component	Material	Material no.
Pump housing	Stainless steel	1.4308
Impeller	Polyamide (PA - GF 35)	
Shaft	Ceramic	
Bearing	Ceramic	
Bearing plate	Stainless steel	1.4301
Can	Stainless steel	1.4301

FLOW MEDIA

- drinking water up to a temperature of 65 °C and a degree of hardness of 14 °dH (temporary hardness)
- heating water as per VDI 2035
- pure, thin, non-aggressive and non-explosive, mineral oil-free media without solid or long-fibre components
- media with a max. viscosity of 10 mm²/s
- operating data must be checked above 20 % glycol

TEMPERATURE RANGE

Ambient temperature:	0 °C to +40 °C
Temperature class:	TF 110
Media temperature:	+2 °C to +110 °C

AMBIENT TEMPERATURE

To avoid condensation forming in the terminal box and stator, the media temperature must always be the same or higher than the ambient temperature.

Ambient temp.	Media temp. min.	Media temp. max.
0	2	95
10	10	95
20	20	95
30	30	95
35	35	90
40	40	70

MOTOR PROTECTION

External motor protection is not required.

INTEGRATED NIGHT ECONOMY FEATURE

When the automatic night economy feature is activated, the circulation pump switches between normal mode and economy mode (characteristic curve MIN). The flow temperature is detected by a temperature sensor, the pump reacts accordingly. For this, it is necessary for the circulation pump to be installed in flow.

MINIMUM INFLOW PRESSURE

Please determine the minimum inflow pressure for corresponding temperature from the following table.

Media temperature	< 75 °C	> 90 °C
Minimum inflow pressure	0.05 bar	0.28 bar

SOUND PRESSURE LEVEL

The sound pressure level is < 45 dB (A).

CHOICE OF CONTROL CHARACTERISTIC

You can set 3 different control modes via the potentiometer on the axial terminal box. Proportional pressure (⚡), fixed speed (⚡) and constant pressure (⊞) can be adjusted continuously variable.



High efficiency pumps with stainless steel housing, electronically controlled

HEP Optimo Basic (N) series, T1 product group

TECHNICAL DATA

TYPE	CONNECTION PIPE	THREADED CONNECTION	INSTALLATION LENGTH (MM)	VOLTAGE / FREQUENCY	P1 (W)	I _{MAX} (A)	NET-WEIGHT (KG)	PRODUCT NO.	EEL
HEP OPTIMO BASIC 25-4.0 N180	1"	1½"	180	230 V 50/60 HZ	4 ... 20	0,26	2,5	0653-34204.2-72	≤ 0,17
HEP OPTIMO BASIC 25-6.0 N180	1"	1½"	180	230 V 50/60 HZ	5 ... 37	0,41	2,5	0653-34206.2-72	≤ 0,18
HEP OPTIMO BASIC 15-4.0 N130	½"	1"	130	230 V 50/60 HZ	4 ... 20	0,26	2,2	0651-34004.2-72	≤ 0,17
HEP OPTIMO BASIC 15-6.0 N130	½"	1"	130	230 V 50/60 HZ	5 ... 37	0,41	2,2	0651-34006.2-72	≤ 0,18
HEP OPTIMO BASIC 20-4.0 N150	¾"	1 ¼"	150	230 V 50/60 HZ	4 ... 20	0,26	2,3	0652-34104.2-72	≤ 0,17
HEP OPTIMO BASIC 20-6.0 N150	¾"	1 ¼"	150	230 V 50/60 HZ	5 ... 37	0,41	2,3	0652-34106.2-72	≤ 0,18
HEP OPTIMO BASIC 25-4.0 N130	1"	1½"	130	230 V 50/60 HZ	4 ... 20	0,26	2,5	0653-34004.2-72	≤ 0,17
HEP OPTIMO BASIC 25-6.0 N130	1"	1½"	130	230 V 50/60 HZ	5 ... 37	0,41	2,5	0653-34006.2-72	≤ 0,18

CONSTANT PRESSURE

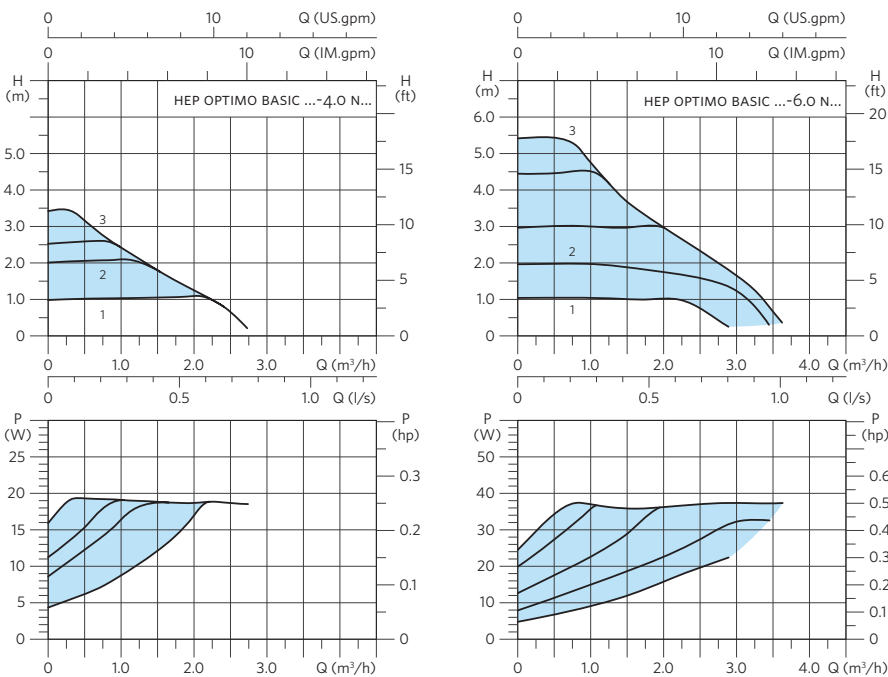

PROPORTIONAL PRESSURE

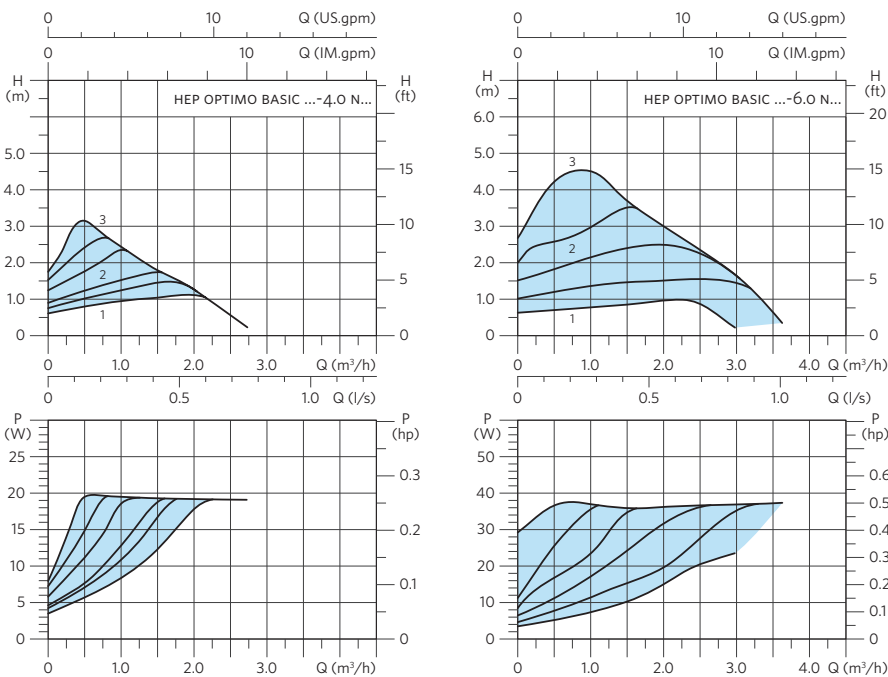

High efficiency pumps with stainless steel housing, electronically controlled

HEP Optimo Basic (N) series, T1 product group

FIXED RPM

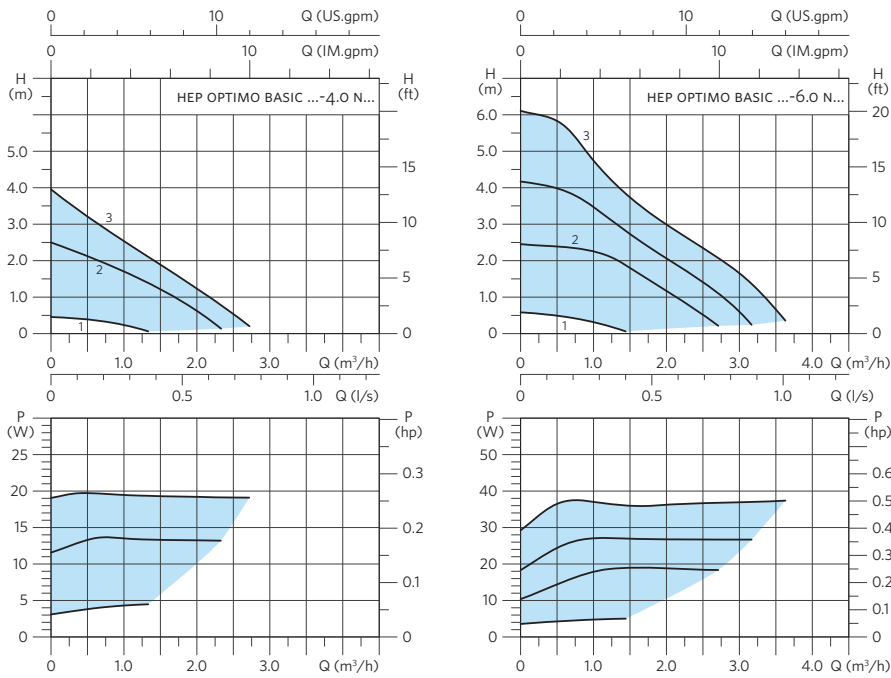

DIMENSIONS

TYPE	L1 (MM)	L2 (MM)	L3 (MM)	L4 (MM)
HEP OPTIMO BASIC (N)	130/180	98	127	163

DIMENSION ILLUSTRATION

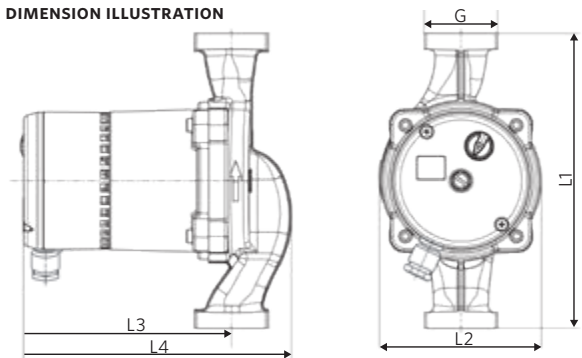

High efficiency pumps with LED display and stainless steel housing, electronically controlled

HEP Optimo (N) series, T1 product group



Insulation shell
with installation length
180 mm included
in delivery.

**BEST
in class**

**ERP
2015⁺**

**5
YEAR
WARRANTY**
★★★★★

**BAFA
GEFÖRDERT**

TECHNICAL DATA

Rate of flow:	up to 4.4 m ³ /h
Pressure head:	4 m/6 m/8 m
Control range:	4-20 W/5-37 W/6-64 W
Media temperature:	+2 °C to +110 °C
Installation length:	130, 150 and 180 mm
Threaded connection:	1", 1½" and 2"
Protection class:	IP 42
Insulation class:	F
Nominal pressure:	PN 10
Control:	Δpc + Δpv + fixed rpm
EEL:	≤ 0.17 HEP Optimo XX-4.0 NXXX ≤ 0.18 HEP Optimo XX-6.0 NXXX ≤ 0.20 HEP Optimo XX-8.0 NXXX

PRODUCT FEATURES

- manual start-up feature
- smooth running
- very low energy consumption
- integrated night economy feature
- air-vent screw
- LED display
- convenient operation
- space-saving axially integrated terminal box
- automatic adjustment to pressure conditions
- stainless steel pump housing
- pre-mounted, screwable angle entry-plug
- compact design
- optical fault indication
- optical display control mode

USE

The electronically controlled HEP Optimo (N) high efficiency wet rotor circulators with LED display and permanent magnet technology are designed for use in heating and solar systems as well as drinking water systems with variable or constant rate of flow.

MODE OF OPERATION ΔP CONTROL IN HEATING SYSTEMS

When thermostatic valves in systems with a long main supply heating pipe (likely for radiator systems) close, the total flow drops. This results in lower pipe resistance in this main pipe, which means the pump has to create lower head. Using proportional pressure mode PP (L) is the preferred setting for such heating systems, as here the pump decreases head at lower flow.

If the main supply heating pipe has not to be taken into consideration, because it is short or has its own pump (likely for underfloor heating systems with in mixing units integrated pumps or drinking water systems), the best mode to use is constant pressure mode CP (E). In such heating systems, it is important always to have constant pressure for the radiators or ufh-circuits, as the pressure loss in the main pipe is not considered and all other consumers are installed in parallel, which does not influence the maximum pressure loss.

CONTROL MODES FOR USE IN SOLAR SYSTEMS

As a rule, solar systems are designed for constant flow. High differential pressure at low flow is required. The fixed speed mode (M) is recommended for this. With this setting, the pump generates the highest possible differential pressure.

In the case of solar systems with a variable flow rate, the setting „Constant pressure“ (E) can alternatively be selected. Here, the differential pressure is kept constant regardless of the respective hydraulic situation of the solar system.

The „Proportional pressure“ (L) control mode may only be selected if the solar pump is used in a heating system with thermostatic valves.

Important: High efficiency pumps with electronically commutated motor (ECM) and integrated automatic control - such as the HEP Optimo - cannot

be operated via external controls, which control pumps via wave packet or leading edge control. The Armstrong series HEP BB2 is recommended for such cases.

MAIN AREAS OF USE

- drinking water systems with fixed speed mode (Display indicates M)

MATERIALS

Component	Material	Material no.
Pump housing	Stainless steel	1.4308
Impeller	Polyamide (PA - GF 35)	
Shaft	Ceramic	
Bearing	Ceramic	
Bearing plate	Stainless steel	1.4301
Can	Stainless steel	1.4301

FLOW MEDIA

- drinking water up to a temperature of 65 °C and a degree of hardness of 14 °dH (temporary hardness)
- heating water as per VDI 2035
- pure, thin, non-aggressive and non-explosive, mineral oil-free media without solid or long-fibre components
- media with a max. viscosity of 10 mm²/s
- operating data must be checked above 20 % glycol

TEMPERATURE RANGE

Ambient temperature:	0 °C to +40 °C
Temperature class:	TF 110
Media temperature:	+2 °C to +110 °C

AMBIENT TEMPERATURE

To avoid condensation forming in the terminal box and stator, the media temperature must always be the same or higher than the ambient temperature.

Ambient temp.	Media temp. min.	Media temp. max.
0	2	110
10	10	110
20	20	110
30	30	95
35	35	90
40	40	70

MOTOR PROTECTION

External motor protection is not required.

INTEGRATED NIGHT ECONOMY FEATURE

When the automatic night economy feature is activated, the circulation pump switches between normal mode and economy mode (characteristic curve MIN). The flow temperature is detected by a temperature sensor, the pump reacts accordingly. For this, it is necessary for the circulation pump to be installed in flow.

MINIMUM INFLOW PRESSURE

Please determine the minimum inflow pressure for corresponding temperature from the following table.

Media temperature	< 75 °C	> 90 °C
Minimum inflow pressure	0.05 bar	0.28 bar

SOUND PRESSURE LEVEL

The sound pressure level is < 45 dB (A).

CHOICE OF CONTROL CHARACTERISTIC

You can set 3 different control modes via the potentiometer on the axial terminal box. Proportional pressure (L), fixed speed (M) and constant pressure (E) can be adjusted continuously variable. The display indicates power consumption in [W] watts. Once the potentiometer is turned, the display first indicates mode of operation and value of set head in [m] meters. If not further turned the display shows the value of power consumption (Watt) and the symbol of the control mode permanently.



High efficiency pumps with LED display and stainless steel housing, electronically controlled

HEP Optimo (N) series, T1 product group

TECHNICAL DATA

TYPE	CONNECTION PIPE	THREADED CONNECTION	INSTALLATION LENGTH (MM)	VOLTAGE / FREQUENCY	P1 (W)	I _{MAX} (A)	NET-WEIGHT (KG)	PRODUCT NO.	EEl
HEP OPTIMO 25-4.0 N180	1"	1½"	180	230 V 50/60 HZ	4 ... 20	0,26	2,5	0653-34204.1-72	≤ 0,17
HEP OPTIMO 25-6.0 N180	1"	1½"	180	230 V 50/60 HZ	5 ... 37	0,41	2,5	0653-34206.1-72	≤ 0,18
HEP OPTIMO 25-8.0 N180	1"	1½"	180	230 V 50/60 HZ	6 ... 64	0,61	2,5	0653-34208.1-72	≤ 0,20
HEP OPTIMO 15-4.0 N130	½"	1"	130	230 V 50/60 HZ	4 ... 20	0,26	2,2	0651-34004.1-72	≤ 0,17
HEP OPTIMO 15-6.0 N130	½"	1"	130	230 V 50/60 HZ	5 ... 37	0,41	2,2	0651-34006.1-72	≤ 0,18
HEP OPTIMO 15-8.0 N130	½"	1"	130	230 V 50/60 HZ	6 ... 64	0,61	2,2	0651-34008.1-72	≤ 0,20
HEP OPTIMO 20-4.0 N150	¾"	1¼"	150	230 V 50/60 HZ	4 ... 20	0,26	2,3	0652-34104.1-72	≤ 0,17
HEP OPTIMO 20-6.0 N150	¾"	1¼"	150	230 V 50/60 HZ	5 ... 37	0,41	2,3	0652-34106.1-72	≤ 0,18
HEP OPTIMO 20-8.0 N150	¾"	1¼"	150	230 V 50/60 HZ	6 ... 64	0,61	2,3	0652-34108.1-72	≤ 0,20
HEP OPTIMO 25-4.0 N130	1"	1½"	130	230 V 50/60 HZ	4 ... 20	0,26	2,5	0653-34004.1-72	≤ 0,17
HEP OPTIMO 25-6.0 N130	1"	1½"	130	230 V 50/60 HZ	5 ... 37	0,41	2,5	0653-34006.1-72	≤ 0,18
HEP OPTIMO 25-8.0 N130	1"	1½"	130	230 V 50/60 HZ	6 ... 64	0,61	2,5	0653-34008.1-72	≤ 0,20

CONSTANT PRESSURE

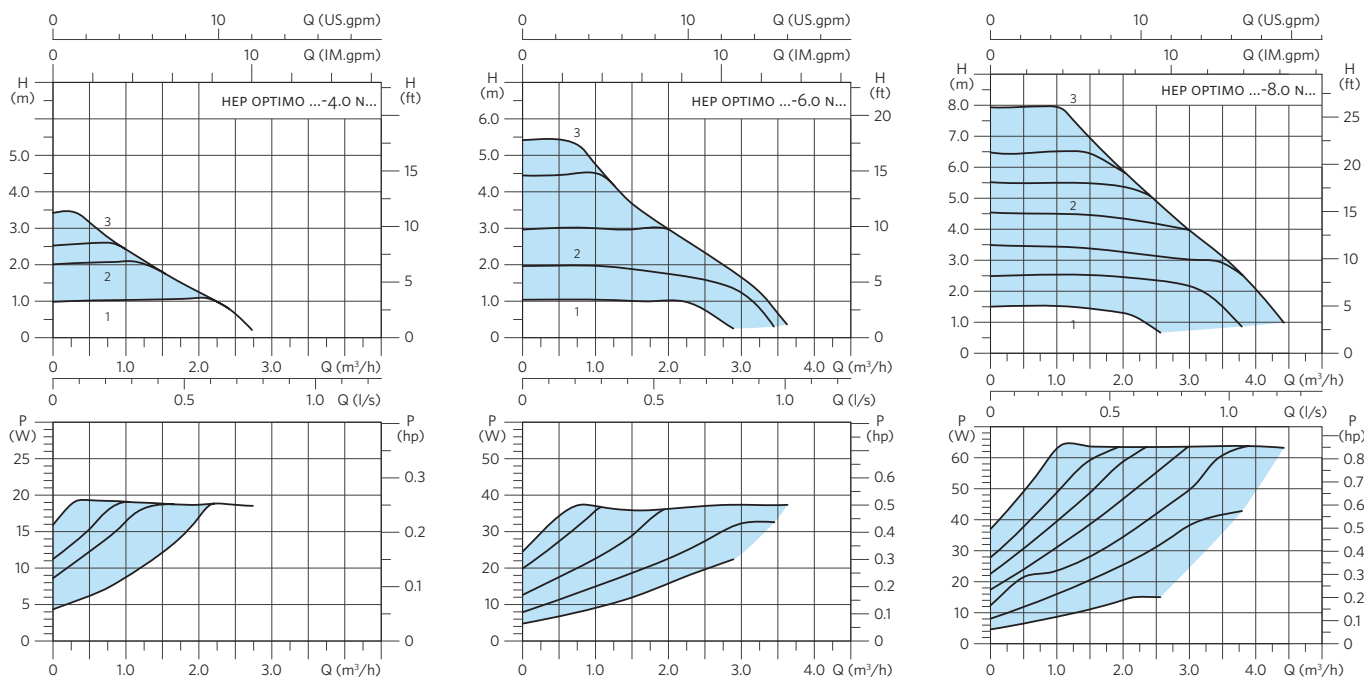

High efficiency pumps with LED display and stainless steel housing, electronically controlled

HEP Optimo (N) series, T1 product group

PROPORTIONAL PRESSURE

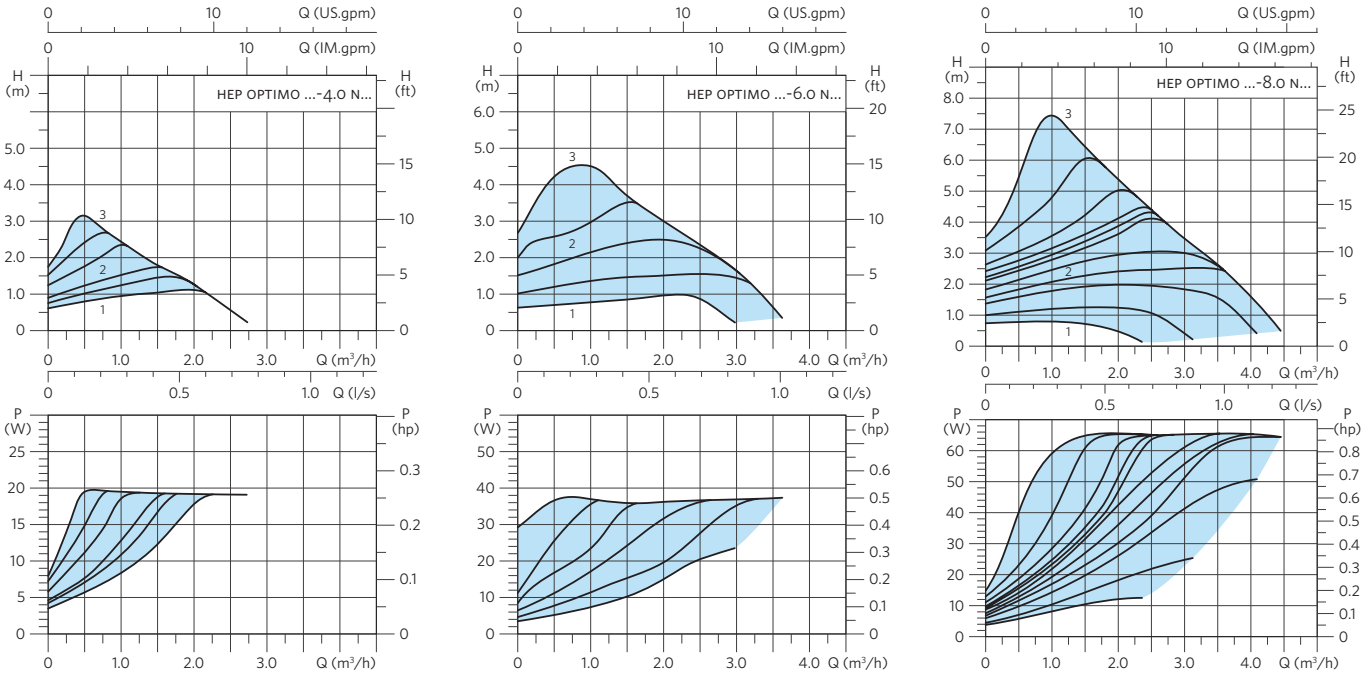

FIXED RPM

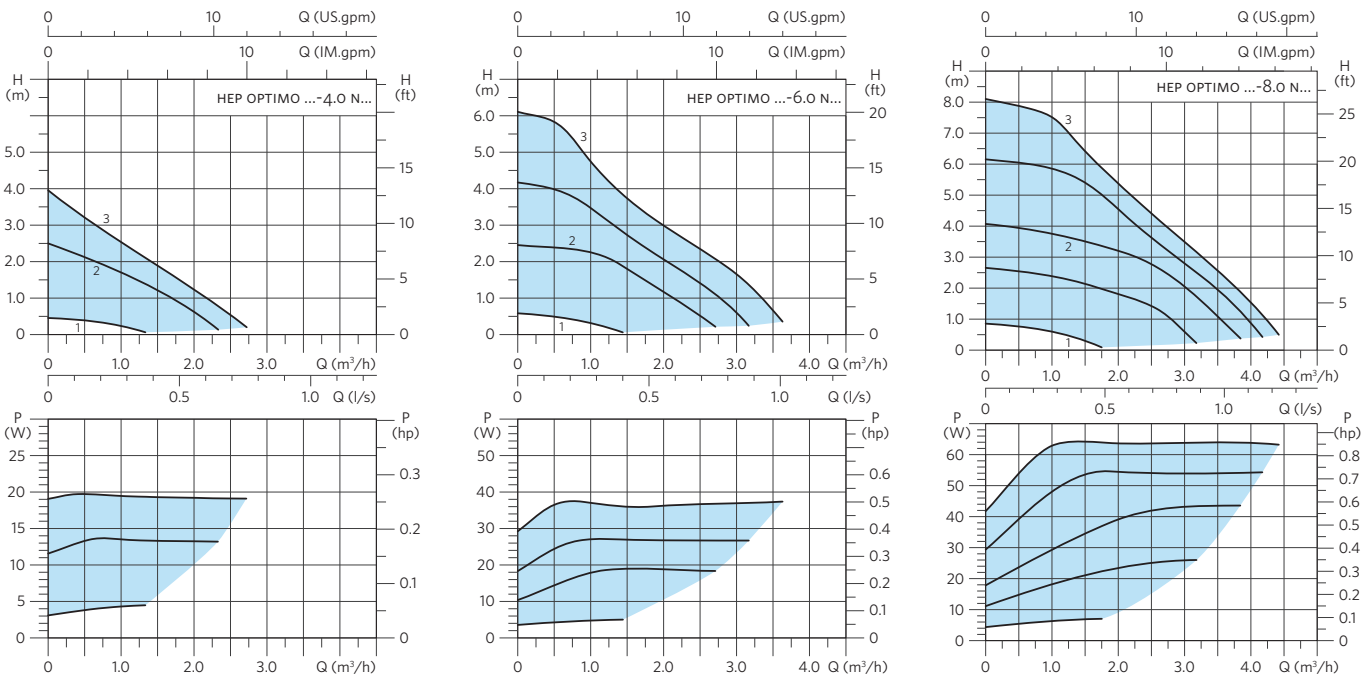

DIMENSIONS

TYPE	L1 (MM)	L2 (MM)	L3 (MM)	L4 (MM)
HEP OPTIMO (N)	130/150/180	98	127	163

DIMENSION ILLUSTRATION

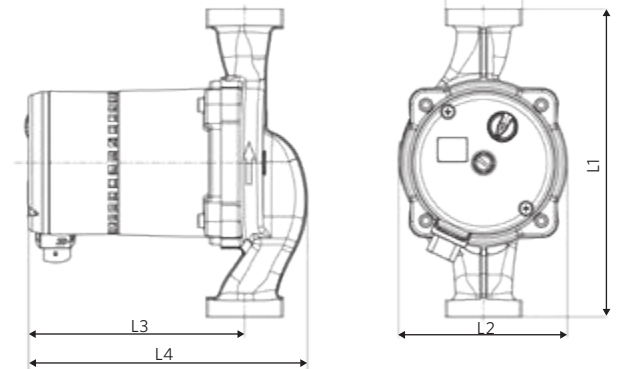

Circulation pumps for drinking water with stainless steel housing, pressure head 7-12 m

BGPA (N) series, T3 product group

**TECHNICAL DATA**

Rate of flow: up to 12.0 m³/h
 Pressure head: up to 12 m
 Media temperature: +2 °C to +110 °C
 Installation length: 180 mm
 Threaded connection: 1¼" and 1½"
 Protection class: IP 44
 Insulation class: H
 Nominal pressure: PN10
 Control: 3-step switch with manual speed selection

PRODUCT FEATURES

- manual start-up feature
- space-saving axially integrated terminal box
- pump housing in stainless steel

USE

The BGPA (N) series circulation pumps are wet rotor circulators designed for use in drinking water systems with a flow rate of > 5 m³/h. They feature a corrosion-resistant housing in stainless steel and are thus designed for use in drinking water circulation systems.

MATERIALS

Component	Material	Material no.
Pump housing	Stainless steel	1.4308
Impeller	Polypropylene (PP - GF 30)	
Shaft	Ceramic	
Bearing	Ceramic	
Bearing plate	Brass	2.0401
Can	Stainless steel	1.4301

TEMPERATURE RANGE

Ambient temperature: 0 °C to +40 °C
 Temperature class: TF 110
 Media temperature: +2 °C to +110 °C

AMBIENT TEMPERATURE

To avoid the build-up of condensation, the ambient temperature must always be lower than the media temperature.

Ambient temp.	Media temp. min.	Media temp. max.
0	2	110
10	10	110
20	20	110
30	30	110
35	35	110
40	40	110

MOTOR PROTECTION

External motor protection is not required.

SPEED SWITCHING

The respective speed is set via a rotary switch integrated in the axial terminal box.

MINIMUM INFLOW PRESSURE

Please determine the minimum inflow pressure for corresponding temperature from the following table.

Media temperature	< 85 °C	90 °C	110 °C
Minimum inflow pressure	0.05 bar	0.3 bar	1.10 bar

SOUND PRESSURE LEVEL

The sound pressure level is < 45 dB (A).

FLOW MEDIA

Only for drinking water up to a temperature of 65 °C and a max. degree of hardness of 14 °dH (temporary hardness).

Circulation pumps for drinking water with stainless steel housing, pressure head 7-12 m

BGPA (N) series, T3 product group

TECHNICAL DATA

TYPE	CONNECTION PIPE	THREADED CONNECTION	INSTALLATION LENGTH (MM)	VOLTAGE / FREQUENCY	P1 (W)	I _{MAX} (A)	NET-WEIGHT (KG)	PRODUCT NO.
BGPA 20-7.0 N180	¾"	1¼"	180	230 V/50 HZ	220 ... 260	1,13	6,3	0352-40207-72
BGPA 20-8.0 N180	¾"	1¼"	180	230 V/50 HZ	260 ... 286	1,25	6,3	0352-40208-72
BGPA 20-10.0 N180	¾"	1¼"	180	230 V/50 HZ	283 ... 357	1,56	6,3	0352-40210-72
BGPA 20-12.0 N180	¾"	1¼"	180	230 V/50 HZ	285 ... 400	1,73	6,3	0352-40212-72
BGPA 25-7.0 N180	1"	1½"	180	230 V/50 HZ	220 ... 260	1,13	6,4	0353-40207-72
BGPA 25-8.0 N180	1"	1½"	180	230 V/50 HZ	260 ... 286	1,25	6,4	0353-40208-72
BGPA 25-10.0 N180	1"	1½"	180	230 V/50 HZ	283 ... 357	1,56	6,4	0353-40210-72
BGPA 25-12.0 N180	1"	1½"	180	230 V/50 HZ	285 ... 400	1,73	6,4	0353-40212-72

PERFORMANCE CURVES

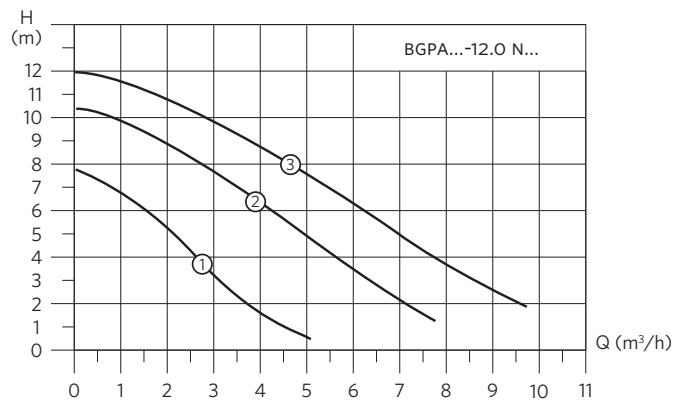
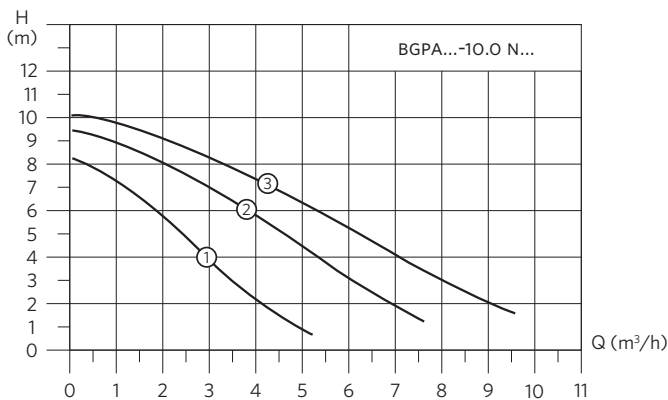
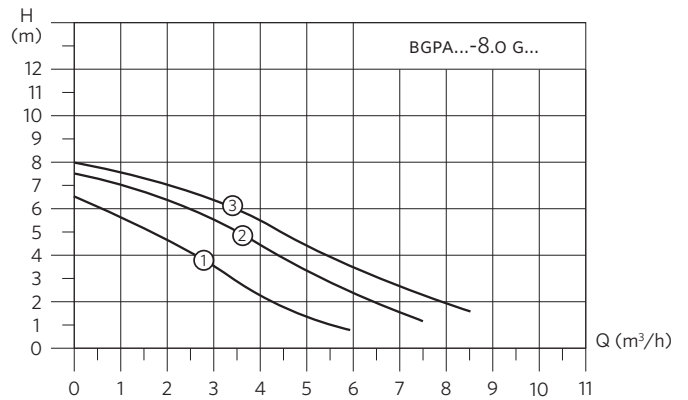
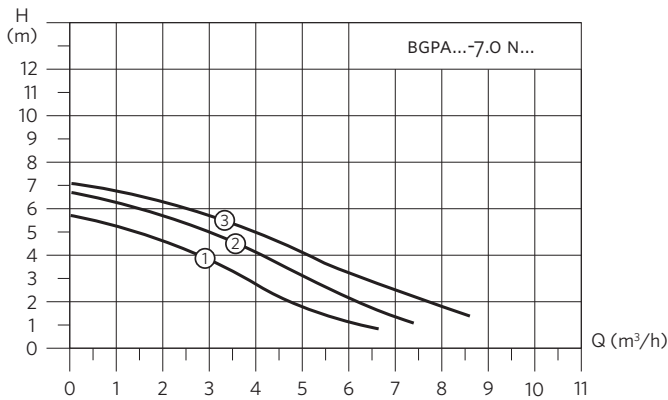

DIMENSIONS

TYPE	L1 (MM)	L2 (MM)	L3 (MM)	L4 (MM)
BGPA (N)	180	135,5	166	206

DIMENSION ILLUSTRATION

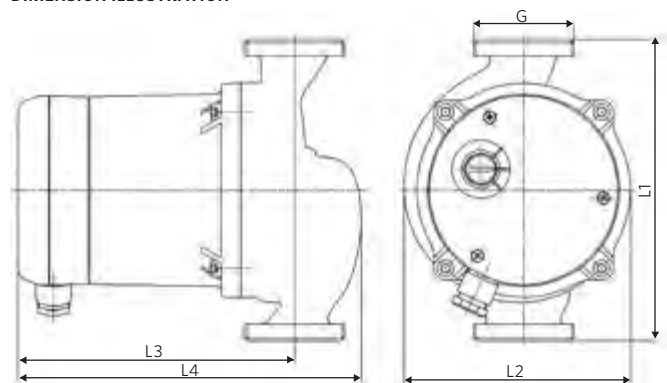

**TECHNICAL DATA**

Rate of flow:	Threaded: up to 9m ³ /h (2.5 l/s) Flanged: up to 83m ³ /h (23.0 l/s)
Pressure head:	6 m/8 m/10 m/12 m/18 m
Control range:	10-90W/10-180W/25-270W/25-480W/25-560W/ 25-1100W/38-1100W/20-1500W/45-1600W
Media temperature:	+2 °C to +110 °C
Installation length:	180 mm (threaded) 220, 250, 280, 340 and 360 mm (flanged)
Circulator connection:	1" and ½" (threaded) DN32, 40, 50, 65, 80 and 100 (flanged)
Protection class:	IP 44
Insulation class:	F
Nominal pressure:	6/10 bar (flanged) 10 bar (threaded)
EEl:	≤ 0.23

Control:

Internal:	<ul style="list-style-type: none"> Constant-pressure Δp or proportional-pressure Δp control Auto Mode with dynamic differential pressure setpoint adjustment Constant speed control with manual selection
External:	<ul style="list-style-type: none"> 0-10 V external speed control MODBUS or Ethernet speed control

PRODUCT FEATURES

- LED display
- manual start-up feature
- smooth running
- very low energy consumption
- collective fault signal
- convenient operation
- front facing integrated terminal box
- automatic adjustment to pressure conditions

USE

The Armstrong AGE3 Z is a high-efficiency, variable speed wet rotor Circulator with ECM technology and permanent magnet rotor. It offers operating flexibility and an industry-leading feature set to support a wide range of heating and cooling applications.

MAIN AREAS OF USE

- heating
- cooling
- plumbing applications

CONTROLS FUNCTION

You can make adjustments with the integrated control keys at the front. The LED display shows the total electrical input power as a numeric value in [W] watts. Different icons at the top of the display show the function, setting and the modes of operation.

MATERIALS

Component	Material	Material no.
Pump housing	Bronze	
Impeller	PES	PES GF 30
Shaft	Stainless steel	AISI 420
Bearing	Graphite	
Bearing plate	Stainless steel	
Can	Stainless steel	AISI 316

TEMPERATURE RANGE

Ambient temperature:	0 °C to +40 °C
Temperature class:	TF 110
Media temperature:	+2 °C to +110 °C

AMBIENT TEMPERATURE

Ambient temp.	Media temp. min.	Media temp. max.
Up to 25 °C	-10 °C	110 °C
30 °C	-10 °C	100 °C
35 °C	-10 °C	90 °C
40 °C	-10 °C	80 °C

MOTOR PROTECTION

External motor protection is not required.

MINIMUM INFLOW PRESSURE

Please determine the minimum inflow pressure for corresponding temperature from the following table.

Media temperature	< 80 °C	90 °C
Minimum inflow pressure	0.05 bar	0.28 bar

SOUND PRESSURE LEVEL

The sound pressure level is < 43 dB (A).

High efficiency pumps with LED display and bronze housing

AGE3 Z series

TECHNICAL DATA

TYPE	CONNECTION PIPE	THREADED CONNECTION	FLANGE	INSTALLATION LENGTH (MM)	VOLTAGE / FREQUENCY	P1 (W)	I _{max} (A)	NET-WEIGHT (KG)	PRODUCT NO.	EEL
AGE3 25-60Z	RP 1"	G1 ½"		180	230/1/50	7 ... 90	0,75	3,5	AGE3-25-60Z	≤ 0.21
AGE3 25-100Z	RP 1"	G1 ½"		180	230/1/50	10 ... 180	1,5	3,5	AGE3-25-100Z	≤ 0.21
AGE3 25-120Z	RP 1"	G1 ½"		180	230/1/50	10 ... 180	1,5	3,5	AGE3-25-120Z	≤ 0.21
AGE3 30-60Z	RP 1¼"	G2"		180	230/1/50	7 ... 90	0,75	3,8	AGE3-30-60Z	≤ 0.21
AGE3 30-100Z	RP 1¼"	G2"		180	230/1/50	10 ... 180	1,5	3,8	AGE3-30-100Z	≤ 0.21
AGE3 30-120Z	RP 1¼"	G2"		180	230/1/50	10 ... 180	1,5	3,8	AGE3-30-120Z	≤ 0.21
AGE3 40-80Z	DN 40		DN 40	250	230/1/50	25 ... 270	3,8	9,6	AGE3-40-80Z	≤ 0.21
AGE3 40-120Z	DN 40		DN 40	250	230/1/50	25 ... 480	3,8	9,6	AGE3-40-120Z	≤ 0.21
AGE3 40-180Z	DN 40		DN 40	250	230/1/50	25 ... 1100	3,8	11,0	AGE3-40-180Z	≤ 0.23
AGE3 50-80Z	DN 50		DN 50	280	230/1/50	25 ... 270	3,8	10,0	AGE3-50-80Z	≤ 0.22
AGE3 50-120Z	DN 50		DN 50	280	230/1/50	25 ... 560	3,8	13,0	AGE3-50-120Z	≤ 0.21
AGE3 50-180Z	DN 50		DN 50	280	230/1/50	25 ... 1100	4,8	30,0	AGE3-50-180Z	≤ 0.23

PERFORMANCE CURVES

AGE3 25-60Z + AGE3 30-60Z

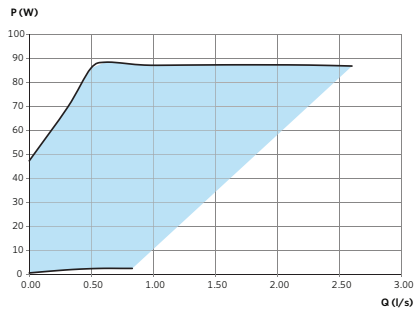
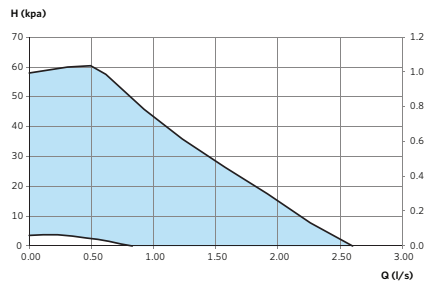

AGE3 25-100Z + AGE3 30-100Z

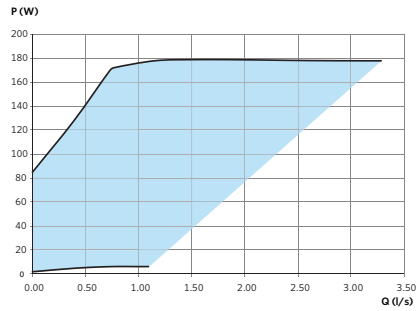
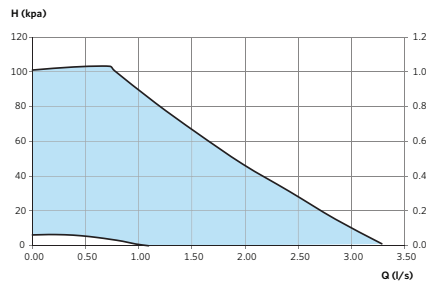

AGE3 25-120Z + AGE3 30-120Z

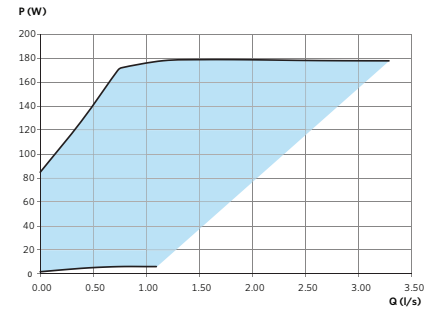
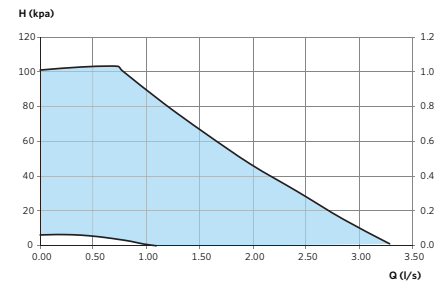

AGE3 40-80Z

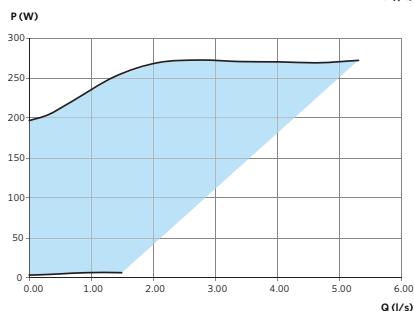
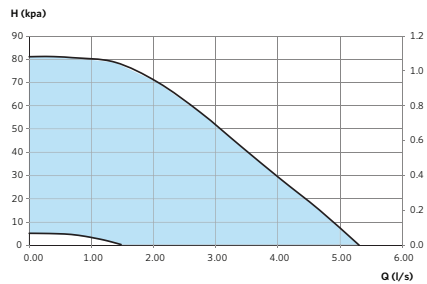

AGE3 40-120Z

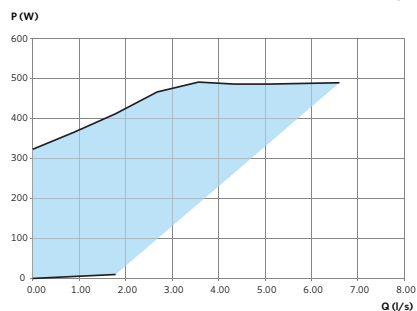
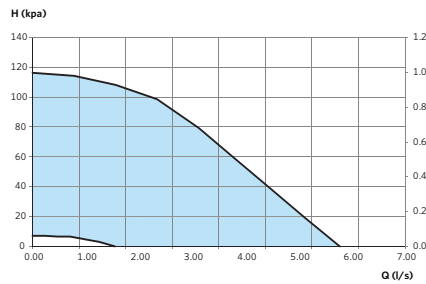

AGE3 40-180Z

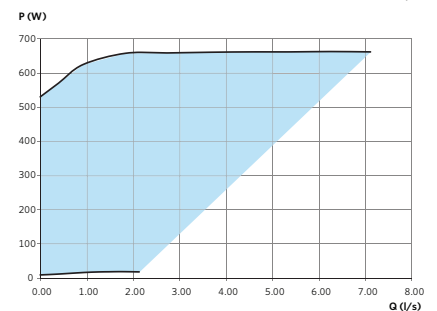
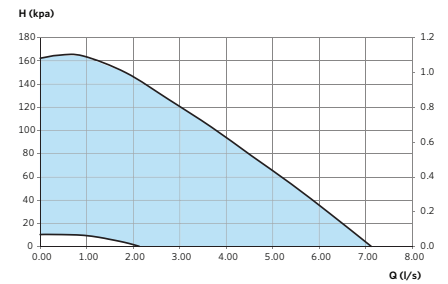

High efficiency pumps with LED display and bronze housing

AGE3 Z series

AGE3 50-80Z

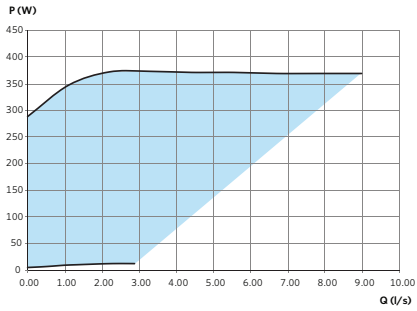
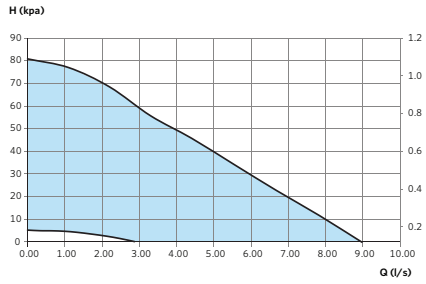

AGE3 50-120Z

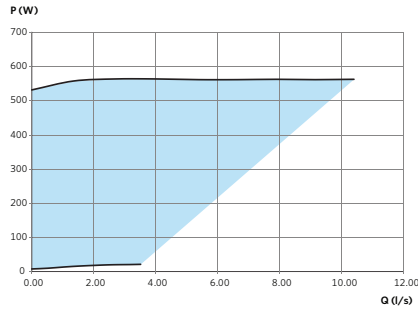
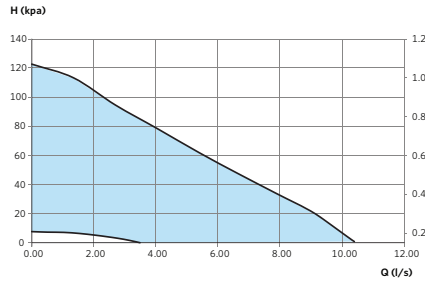

AGE3 50-180Z

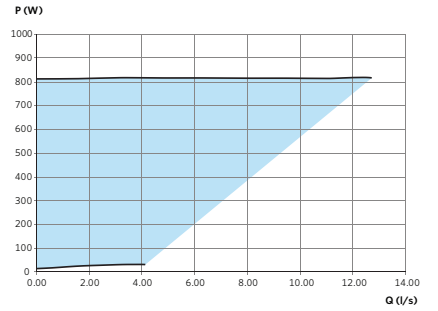
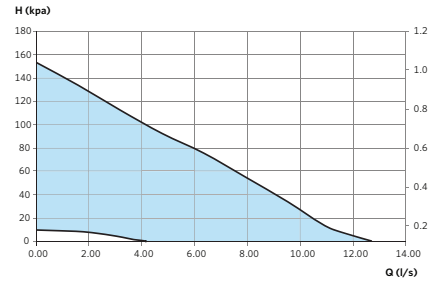

DIMENSIONS

TYPE	A (MM)	B (MM)	C (MM)	D (MM)	E (MM)
AGE3 25-60Z	180	95	180	58.5	58.5
AGE3 25-100Z	180	95	180	58.5	58.5
AGE3 25-120Z	180	95	180	58.5	58.5
AGE3 30-60Z	180	95	180	58.5	58.5
AGE3 30-100Z	180	95	180	58.5	58.5
AGE3 30-120Z	180	95	180	58.5	58.5
AGE3 40-80Z	260	65	220	72	72
AGE3 40-120Z	260	65	250	75	75
AGE3 40-180Z	357	65	250	90	90
AGE3 50-80Z	333	72	280	75	92
AGE3 50-120Z	333	72	280	75	92
AGE3 50-180Z	343	72	280	90	92

DIMENSION ILLUSTRATION (THREADED VERSION)

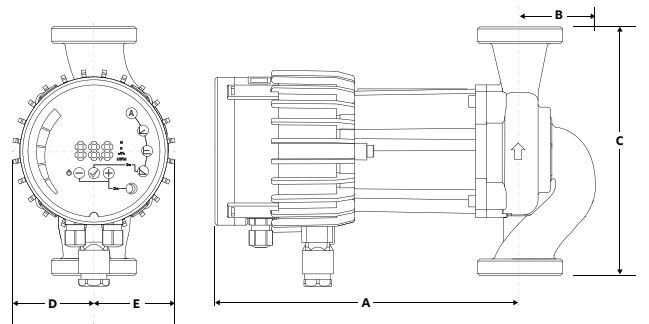

DIMENSION ILLUSTRATION (FLANGE VERSION)

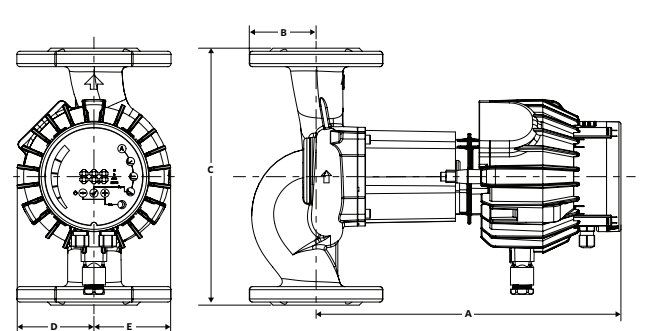

High efficiency pumps with LCD display, electronically controlled

HEP Optimo L Solar series, S2 product group



Insulation shell
with installation length
180 mm included
in delivery.



TECHNICAL DATA

Rate of flow:	up to 10 m ³ /h
Pressure head:	8 m/10 m
Control range:	15-180 W/15-195 W
Media temperature:	+2 °C to +110 °C
Installation length:	180 mm (threaded)/220 mm (flanged)
Circulator connection:	1½" and 2" (threaded)/DN 32 and 40 (flanged)
Protection class:	IP 42
Insulation class:	F
Nominal pressure:	PN 10
EEL:	≤ 0.23 HEP Optimo L XX-8.0 GXXX ≤ 0.23 HEP Optimo L XX-10.0 GXXX

Control:

Internal:	Δpc + Δpv + fixed rpm
External:	<ul style="list-style-type: none"> digital: PWM (characteristic lines for heating and solar per VDMA device paper 24224) frequency f nominal: 100-1000 Hz voltage U nominal: 5-15 V power I: 10 mA analogue: 0-10 V with cable break detection power I: 1 mA impedance: 10 kOhm

Omnibus fault message: Selector switch, potential-free, power max. 2 A/240 VAC

Power supply for external unit: Voltage DC 12 V, power max. 100 mA

PRODUCT FEATURES

- LCD display
- manual start-up feature
- smooth running
- very low energy consumption
- air-vent screw
- collective fault signal
- convenient operation
- axially integrated terminal box
- automatic adjustment to pressure conditions
- cataphoretic coated pump housing

USE

The electronically controlled HEP Optimo L Solar high efficiency wet rotor circulators with LCD display and permanent magnet technology are designed for use in heating systems with variable or constant rate of flow. The cataphoretic coated pump housing is stainless.

MAIN AREAS OF USE

- solar systems

CONTROLS FUNCTION

You can make adjustments with the integrated control keys at the front. The LCD display shows the total electrical input power as a numeric value in [W] watts. Different icons at the top of the display show the function, setting and the modes of operation.

MATERIALS

Component	Material	Material No.
Pump body	Grey-cast iron	0.6020
Impeller	Polyamide (PA - GF 35)	
Shaft	Ceramic	
Bearing	Ceramic	
Bearing plate	Stainless steel	1.4301
Can	Stainless steel	1.4301

FLOW MEDIA

- heating water as per VDI 2035
- pure, thin, non-aggressive and non-explosive, mineral oil-free media without solid or long-fibre components
- media with a max. viscosity of 10 mm²/s
- operating data must be checked above 20 % glycol

TEMPERATURE RANGE

Ambient temperature:	0 °C to +40 °C
Temperature class:	TF 110
Media temperature:	+2 °C to +110 °C

AMBIENT TEMPERATURE

To avoid condensation forming in the terminal box and stator, the media temperature must always be the same or higher than the ambient temperature.

Ambient temp.	Media temp. min.	Media temp. max.
0	2	110
10	10	110
20	20	110
30	30	95
35	35	90
40	40	70

MOTOR PROTECTION

External motor protection is not required.

MINIMUM INFLOW PRESSURE

Please determine the minimum inflow pressure for corresponding temperature from the following table.

Media temperature	< 75 °C	> 90 °C
Minimum inflow pressure	0.05 bar	0.45 bar

SOUND PRESSURE LEVEL

The sound pressure level is < 45 dB (A).

High efficiency pumps with LCD display, electronically controlled

HEP Optimo L Solar series, S2 product group

TECHNICAL DATA

TYPE	CONNECTION PIPE	THREADED CONNECTION	FLANGE	INSTALLATION LENGTH (MM)	VOLTAGE / FREQUENCY	P1 (W)	I _{MAX} (A)	NET-WEIGHT (KG)	PRODUCT NO.	EEI
HEP OPTIMO L SOLAR 25-8.0 G180	1"	1½"	-	180	230 V 50/60 HZ	15 ... 180	0,90	5,3	0313-64208.1-72	≤ 0,23
HEP OPTIMO L SOLAR 25-10.0 G180	1"	1½"	-	180	230 V 50/60 HZ	15 ... 195	0,90	5,3	0313-64210.1-72	≤ 0,23
HEP OPTIMO L SOLAR 30-8.0 G180	1¼"	2"	-	180	230 V 50/60 HZ	15 ... 180	0,90	5,6	0314-64208.1-72	≤ 0,23
HEP OPTIMO L SOLAR 30-10.0 G180	1¼"	2"	-	180	230 V 50/60 HZ	15 ... 195	0,90	5,6	0314-64210.1-72	≤ 0,23
HEP OPTIMO L SOLAR 32-8.0 G220	-	-	DN 32	220	230 V 50/60 HZ	15 ... 180	0,90	9,3	0314-94208.1-72	≤ 0,23
HEP OPTIMO L SOLAR 32-10.0 G220	-	-	DN 32	220	230 V 50/60 HZ	15 ... 195	0,90	9,3	0314-94210.1-72	≤ 0,23
HEP OPTIMO L SOLAR 40-8.0 G220	-	-	DN 40	220	230 V 50/60 HZ	15 ... 180	0,90	9,3	0315-94208.1-72	≤ 0,23
HEP OPTIMO L SOLAR 40-10.0 G220	-	-	DN 40	220	230 V 50/60 HZ	15 ... 195	0,90	9,3	0315-94210.1-72	≤ 0,23

PROPORTIONAL PRESSURE

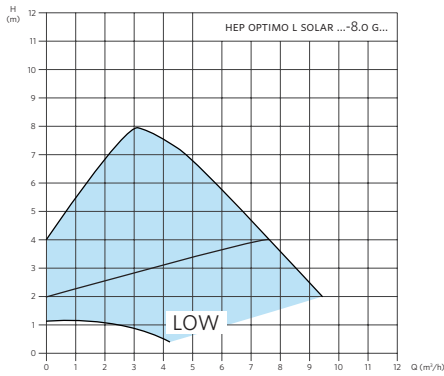

CONSTANT PRESSURE

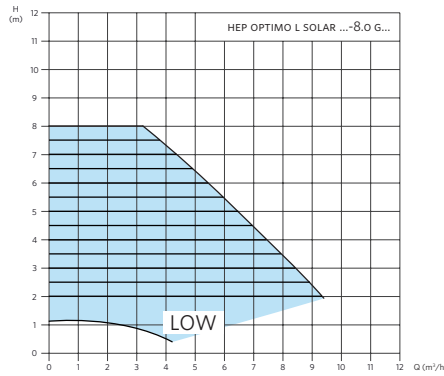

FIXED RPM

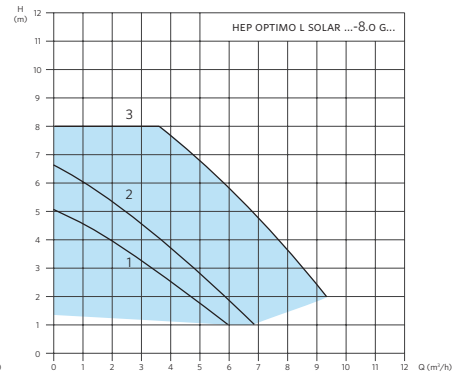

PROPORTIONAL PRESSURE

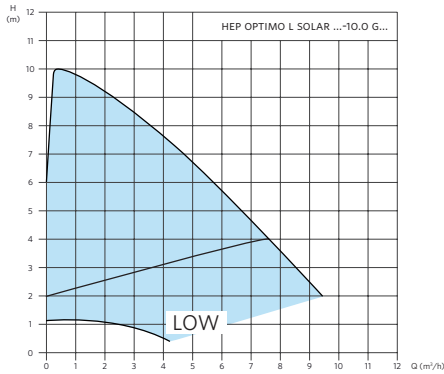

CONSTANT PRESSURE

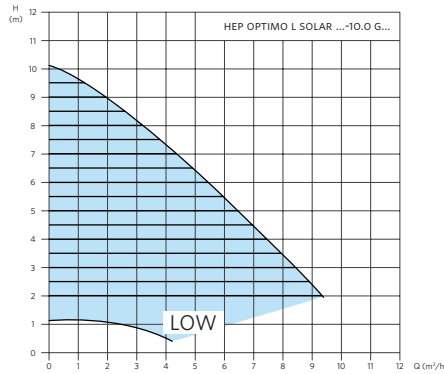

FIXED RPM

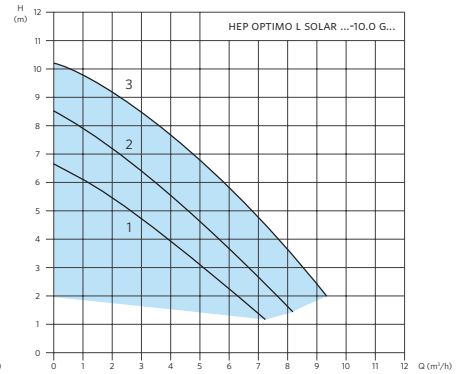

DIMENSIONS

TYPE	L1 (MM)	L2 (MM)	L3 (MM)	L4 (MM)
HEP OPTIMO L (THREAD)	180	267	178	225
HEP OPTIMO L (FLANGE)	220	267	177.5	245

DIMENSION ILLUSTRATION

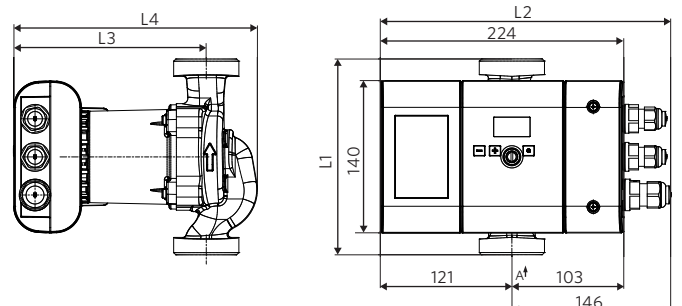

HEP BB2

Babelbox BB2 and HEP PWM , S3 product group



**INDUSTRIE
PREIS 2014**
BEST OF

TECHNICAL DATA

Supply voltage:	230 V
Power input:	0.25 W
Signal input leading edge:	0-230 V
Signal input trailing edge:	0-230 V
Signal input wave packet:	0-230 V, 50 Hz
Signal input power consumption:	1.5 mA
PWM output:	12 V DC, 15 mA
Frequency:	1000 Hz
Ambient temperature:	0 °C to +70 °C
Cable connection input:	3 x M16
Dimensions:	115 x 117 x 50 mm
Weight:	0.3 kg

USE

The Babelbox BB2 is designed for use in heating systems in which an on-site controller pulses a standard pump via the power line and this pump is to be replaced by a high-efficiency pump. High-efficiency pumps do not react to a pulsed power line and therefore cannot simply substitute for a standard pump. Interposing the Babelbox BB2 solves this issue while retaining the control functions of the system.

MODE OF OPERATION

The BB2 automatically detects if an on-site controller is pulsing the power line via a wave packet or is outputting leading or trailing edge voltage. The BB2 converts this into a PWM signal which is identified by the Armstrong PWM pump. Just like the standard pump previously, its power is also then controlled. An integrated LED shows the presence of voltage from the on-site controller.

MAIN AREAS OF USE

All applications in which a standard pump controlled externally by the power line is to be replaced by a high-efficiency pump.

- Return flow boost
- Solar installation
- Differential temperature controlled underfloor heating
- Storage charging circuit
- Freshwater station (suitability should be checked with the manufacturer due to the highly sensitive controlled system)

INSTALLATION

Stable cable bushings and elevator terminals enable easy installation. The BB2 must be connected to 230 V voltage, with the PWM pump and the pulsed power line. Fully automatic detection of the input signal means no further settings need be adjusted.

MOTOR (HIGH EFFICIENT ECM TECHNOLOGY)

Power supply nominal:	200-230 V, 50-60 Hz
Power consumption:	Version 4 m (4-25 W); Version 7 m (4-66 W)
Power consumption stand-by PWM:	0.8 W

PWM CONNECTION

PWM input:	
Frequency f nominal:	100-2000 Hz
Voltage U nominal:	5-24 V
Power PWM to 12 V:	max. 10 mA
Power PWM to 24 V:	max. 20 mA
Insulation voltage optocoupler:	5300 VRMS (T_{ein} / T_{pwm}) x 100

STANDARDS

8/37/EG, 2006/95/EG, 2004/108/EG
EN 60335-1, EN 60335-2-51,
EN 55014-1:2006+A1:2009,
EN 55014-2:1997+A1.2001+A2:2008
EN 61000-6:2007, EN 61000-6-3:2007,
EN 50366, EN 61000-3-2, EN 61000-3-3,
EN 55014-1, EN 55014-2

THE BABELBOX BB2 SOLUTION



It was previously not possible to replace standard heating pumps driven by wave packet, leading or trailing edge control with high-efficiency pumps. For the first time, this can now be done with the Babelbox BB2.

FULLY AUTOMATIC SIGNAL DETECTION



Typical high-efficiency pumps require a 230 V constant voltage supply. If, however, a high-efficiency pump is connected to a variable power voltage supply (solar controller, freshwater station controller, charging controller etc.), it reacts neither to a wave packet nor leading edge control as desired. This is where the Babelbox BB2 from Armstrong comes in. It independently and fully automatically detects which signal is being output by the controller of the standard pump and converts it into a PWM signal which can be understood by the high-efficiency pump, controlling the latter in just the same way as the previously installed standard pump. The voltage supply for the high-efficiency pump itself comes from a separate 230 V connection.

TECHNICAL DATA

TYPE	CONNECTION PIPE	THREADED CONNECTION	INSTALLATION LENGTH (MM)	P1 (W)	I _{max} (A)	NET-WEIGHT (KG)	PRODUCT NO.
HEP BB2 25-4.0 G180	1"	1 1/2"	180	4 ... 25	0,3	3,3	0323-34204.7-72
HEP BB2 25-7.0 G180	1"	1 1/2"	180	4 ... 66	0,6	3,3	0323-34207.7-72
HEP BB2 30-4.0 G180	1 1/4"	2"	180	4 ... 25	0,3	3,3	0324-34204.7-72
HEP BB2 30-7.0 G180	1 1/4"	2"	180	4 ... 66	0,6	3,3	0324-34207.7-72
HEP BB2 15-4.0 G130	1/2"	1"	130	4 ... 25	0,3	3,3	0321-34004.7-72
HEP BB2 15-7.0 G130	1/2"	1"	130	4 ... 66	0,6	3,3	0321-34007.7-72
HEP BB2 25-4.0 G130	1"	1 1/2"	130	4 ... 25	0,3	3,3	0323-34004.7-72
HEP BB2 25-7.0 G130	1"	1 1/2"	130	4 ... 66	0,6	3,3	0323-34007.7-72

PERFORMANCE CURVES

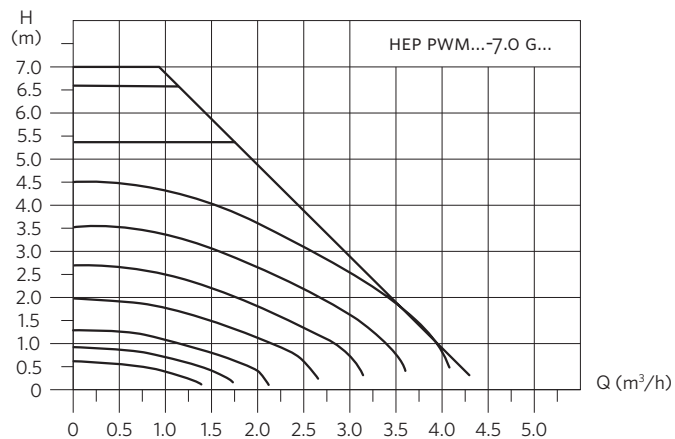
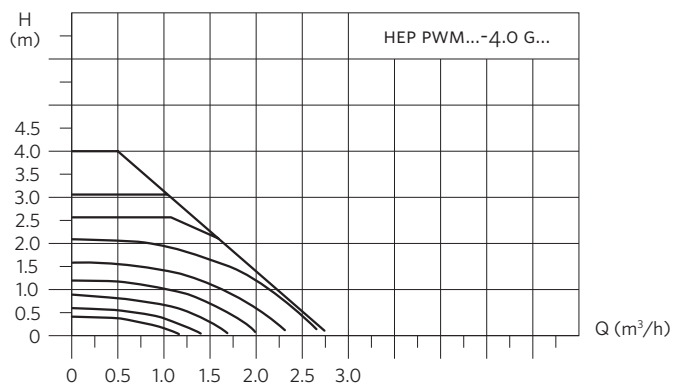

High efficiency pumps with LED display, electronically controlled and protected against condensation

HEP Optimo Geo series, G1 product group



Insulation shell with installation length 180 mm included in delivery.

BEST in class

ERP 2015+

5 YEAR WARRANTY
★★★★★

BAFA GEFÖRDERT

TECHNICAL DATA

Rate of flow:	up to 3.6 m ³ /h
Pressure head:	4 m/6 m
Control range:	4-20 W/5-37 W
Media temperature:	-15 °C to +110 °C
Installation length:	130 and 180 mm
Threaded connection:	1", 1½" and 2"
Protection class:	IP 42
Insulation class:	F
Nominal pressure:	PN 10
Control:	Δpc + Δpv + fixed rpm
EEL:	≤ 0,17 HEP Optimo Geo XX-4.0 GXXX ≤ 0,18 HEP Optimo Geo XX-6.0 GXXX

PRODUCT FEATURES

- potted motor
- manual start-up feature
- smooth running
- very low energy consumption
- integrated night economy feature
- air-vent screw
- LED display
- convenient operation
- space-saving axially integrated terminal box
- automatic adjustment to pressure conditions
- cataphoretic coated pump housing
- pre-mounted, screwable angle entry-plug
- compact design

USE

The electronically controlled HEP Optimo Geo high efficiency wet rotor circulators with LED display and permanent magnet technology are designed for use in heating and cold water circulation systems with variable or constant rate of flow. The motor integrity offers a sealed winding protection from ingress of condensation. The cataphoretic coated pump housing is stainless.

MODE OF OPERATION ΔP CONTROL IN HEATING SYSTEMS

When thermostatic valves in systems with a long main supply heating pipe (likely for radiator systems) close, the total flow drops. This results in lower pipe resistance in this main pipe, which means the pump has to create lower head. Using proportional pressure mode (L) is the best setting for such heating systems, as here the pump decreases head at lower flow.

If the main supply heating pipe has not to be taken into consideration, because it is short or has its own pump (likely for underfloor heating systems with in mixing units integrated pumps), the best mode to use is constant pressure mode (B). In such heating systems, it is important always to have constant pressure for the radiators or ufh-circuits, as the pressure loss in the main pipe is not considered and all other consumers are installed in parallel, which does not influence the maximum pressure loss.

MAIN AREAS OF USE

Heating, air-conditioning and industry systems as

- dual pipe system
- underfloor heating
- boiler/primary circuit
- storage charging circuit
- solar systems and heating pumps

MATERIALS

Component	Material	Material no.
Pump housing	Grey-cast iron	0.6020
Impeller	Polyamide (PA - GF 35)	
Shaft	Ceramic	
Bearing	Ceramic	
Bearing plate	Stainless steel	1.4301
Can	Stainless steel	1.4301

FLOW MEDIA

- heating water as per VDI 2035
- pure, thin, non-aggressive and non-explosive, mineral oil-free media without solid or long-fibre components
- media with a max. viscosity of 10 mm²/s
- operating data must be checked above 20 % glycol

TEMPERATURE RANGE

Ambient temperature:	0 °C to +40 °C
Temperature class:	TF 110
Media temperature:	-15 °C to +110 °C

AMBIENT TEMPERATURE

To avoid condensation forming in the terminal box and stator, the media temperature must always be the same or higher than the ambient temperature.

Ambient temp.	Media temp. min.	Media temp. max.
0	2	110
10	10	110
20	20	110
30	30	95
35	35	90
40	40	70

MOTOR PROTECTION

External motor protection is not required.

INTEGRATED NIGHT ECONOMY FEATURE

When the automatic night economy feature is activated, the circulation pump switches between normal mode and economy mode (characteristic curve MIN). The flow temperature is detected by a temperature sensor, the pump reacts accordingly. For this, it is necessary for the circulation pump to be installed in flow.

MINIMUM INFLOW PRESSURE

Please determine the minimum inflow pressure for corresponding temperature from the following table.

Media temperature	< 75 °C	> 90 °C
Minimum inflow pressure	0.05 bar	0.28 bar

SOUND PRESSURE LEVEL

The sound pressure level is < 45 dB (A).

CHOICE OF CONTROL CHARACTERISTIC

You can set 3 different control modes via the potentiometer on the axial terminal box. Proportional pressure (L), fixed speed (M) and constant pressure (B) can be adjusted continuously variable. The display indicates power consumption in [W] watts. Once the potentiometer is turned, the flashing display first indicates mode of operation and value of set head in [m] meters. If not further turned the display shows the value of power consumption (Watt) and the symbol of the control mode permanently.



High efficiency pumps with LED display, electronically controlled and protected against condensation

HEP Optimo Geo series, G1 product group

TECHNICAL DATA

TYPE	CONNECTION PIPE	THREADED CONNECTION	INSTALLATION LENGTH (MM)	VOLTAGE / FREQUENCY	P1 (W)	I _{MAX} (A)	NET-WEIGHT (KG)	PRODUCT NO.	EEL
HEP OPTIMO GEO 25-4.0 G180	1"	1½"	180	230 V 50/60 HZ	4 ... 20	0,26	2,8	0623-34204.8-72	≤ 0,17
HEP OPTIMO GEO 25-6.0 G180	1"	1½"	180	230 V 50/60 HZ	5 ... 37	0,41	2,8	0623-34206.8-72	≤ 0,18
HEP OPTIMO GEO 30-4.0 G180	1¼"	2"	180	230 V 50/60 HZ	4 ... 20	0,26	2,9	0624-34204.8-72	≤ 0,17
HEP OPTIMO GEO 30-6.0 G180	1¼"	2"	180	230 V 50/60 HZ	5 ... 37	0,41	2,9	0624-34206.8-72	≤ 0,18
HEP OPTIMO GEO 15-4.0 G130	½"	1"	130	230 V 50/60 HZ	4 ... 20	0,26	2,4	0621-34004.8-72	≤ 0,17
HEP OPTIMO GEO 15-6.0 G130	½"	1"	130	230 V 50/60 HZ	5 ... 37	0,41	2,4	0621-34006.8-72	≤ 0,18
HEP OPTIMO GEO 20-4.0 G130	¾"	1¼"	130	230 V 50/60 HZ	4 ... 20	0,26	2,5	0622-34004.8-72	≤ 0,17
HEP OPTIMO GEO 20-6.0 G130	¾"	1¼"	130	230 V 50/60 HZ	5 ... 37	0,41	2,5	0622-34006.8-72	≤ 0,18
HEP OPTIMO GEO 25-4.0 G130	1"	1½"	130	230 V 50/60 HZ	4 ... 20	0,26	2,6	0623-34004.8-72	≤ 0,17
HEP OPTIMO GEO 25-6.0 G130	1"	1½"	130	230 V 50/60 HZ	5 ... 37	0,41	2,6	0623-34006.8-72	≤ 0,18

CONSTANT PRESSURE

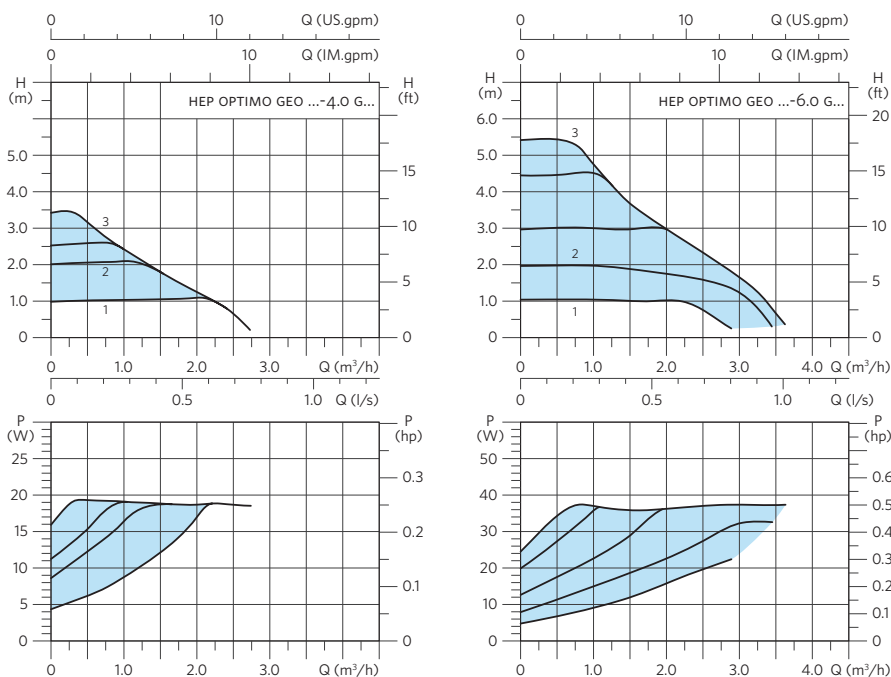

PROPORTIONAL PRESSURE

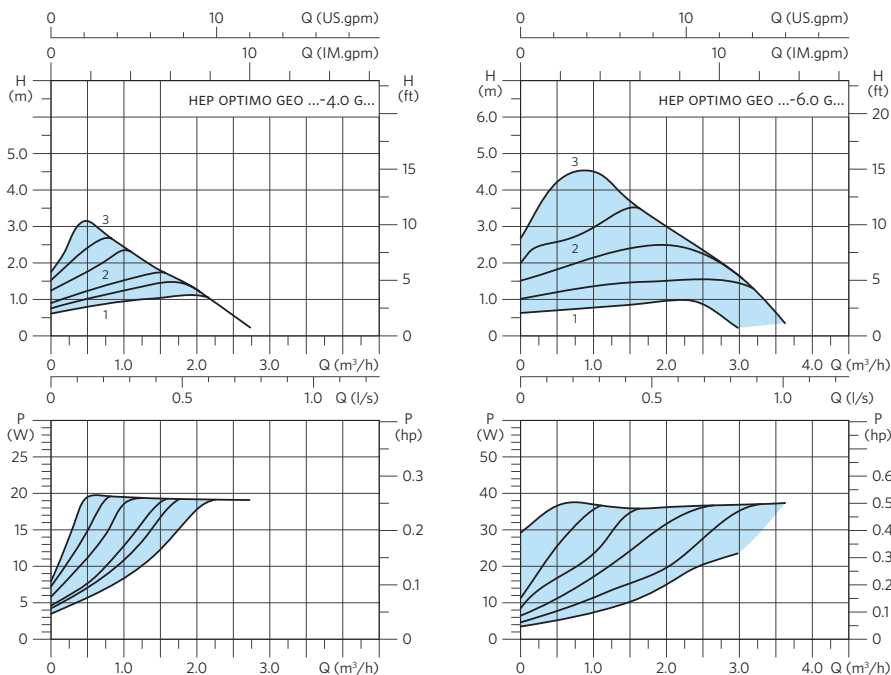

High efficiency pumps with LED display, electronically controlled and protected against condensation

HEP Optimo Geo series, G1 product group

FIXED RPM

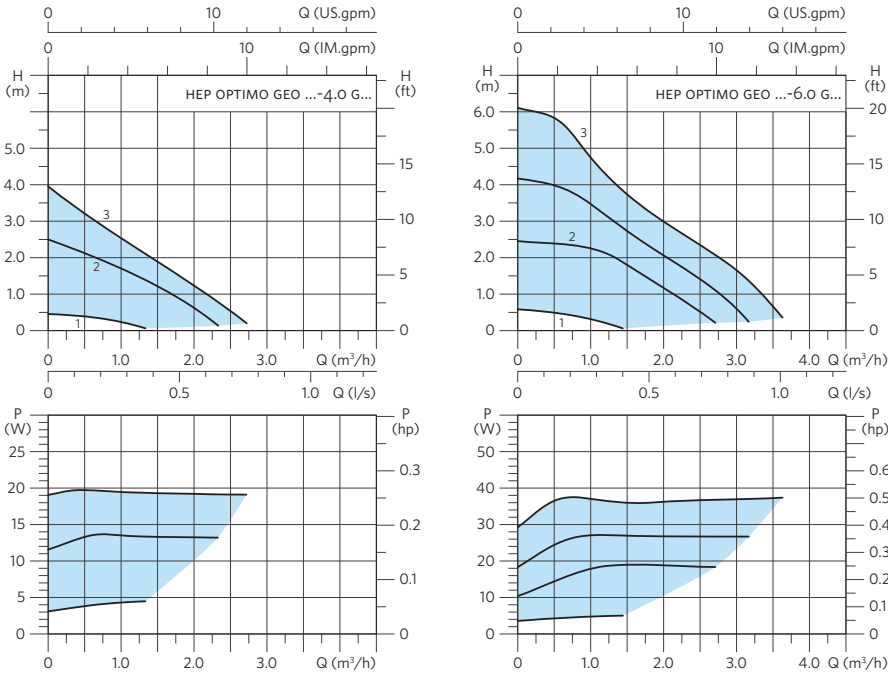

DIMENSIONS

TYPE	L1 (MM)	L2 (MM)	L3 (MM)	L4 (MM)
HEP OPTIMO GEO	130/180	98	127	163

DIMENSION ILLUSTRATION

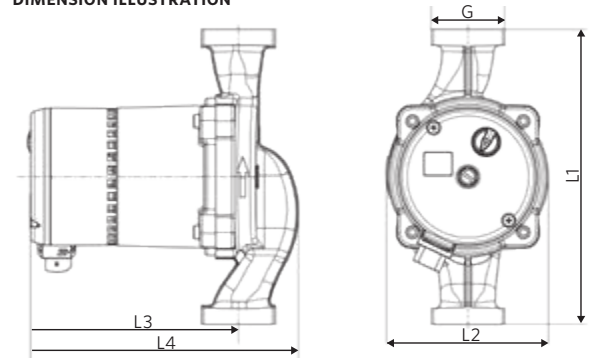

High efficiency pumps with LCD display, electronically controlled and protected against condensation

HEP Optimo L Geo series, G2 product group



Insulation shell
with installation length
180 mm included
in delivery.

ERP
2015⁺

5
YEAR
WARRANTY
★★★★★

TECHNICAL DATA

Rate of flow: up to 10 m³/h
 Pressure head: 8 m/10 m
 Control range: 15-180 W/15-195 W
 Media temperature: -15 °C to +95 °C
 Installation length: 180 mm (threaded)/220 mm (flanged)
 Circulator connection: 1½" and 2" (threaded)/DN 32 and 40 (flanged)
 Protection class: IP 42
 Insulation class: F
 Nominal pressure: PN 10
 EEI: ≤ 0.23 HEP Optimo L XX-8.0 GXXX
 ≤ 0.23 HEP Optimo L XX-10.0 GXXX

Control:

Internal: Δpc + Δpv + fixed rpm
 External:

- digital: PWM (characteristic lines for heating and solar per VDMA device paper 24224)
 frequency f nominal: 100-1000 Hz
 voltage U nominal: 5-15 V
 power I: 10 mA
- analogue: 0-10 V with cable break detection
 power I: 1 mA
 impedance: 10 kOhm

Omnibus fault message: Selector switch, potential-free,
 power max. 2 A/240 VAC

Power supply for external unit: Voltage DC 12 V, power max. 100 mA

PRODUCT FEATURES

- potted motor
- LCD display
- manual start-up feature
- smooth running
- very low energy consumption
- air-vent screw
- collective fault signal
- convenient operation
- axially integrated terminal box
- automatic adjustment to pressure conditions
- cataphoretic coated pump housing

USE

The electronically controlled HEP Optimo L Geo high efficiency wet rotor circulators with LCD display and permanent magnet technology are designed for use in heating systems with variable or constant rate of flow. The cataphoretic coated pump housing is stainless.

MAIN AREAS OF USE

Heating, air-conditioning and industry systems as

- dual pipe system
- single pipe system
- underfloor heating
- boiler/primary circuit
- storage charging circuit
- solar systems and heating pumps

CONTROLS FUNCTION

You can make adjustments with the integrated control keys at the front. The LCD display shows the total electrical input power as a numeric value in [W] watts. Different icons at the top of the display show the function, setting and the modes of operation.

MATERIALS

Component	Material	Material No.
Pump body	Grey-cast iron	0.6020
Impeller	Polyamide (PA - GF 35)	
Shaft	Ceramic	
Bearing	Ceramic	
Bearing plate	Stainless steel	1.4301
Can	Stainless steel	1.4301

FLOW MEDIA

- heating water as per VDI 2035
- pure, thin, non-aggressive and non-explosive, mineral oil-free media without solid or long-fibre components
- media with a max. viscosity of 10 mm²/s
- operating data must be checked above 20 % glycol

TEMPERATURE RANGE

Ambient temperature: 0 °C to +40 °C
 Temperature class: TF 95
 Media temperature: -15 °C to +95 °C

AMBIENT TEMPERATURE

To avoid condensation forming in the terminal box and stator, the media temperature must always be the same or higher than the ambient temperature.

Ambient temp.	Media temp. min.	Media temp. max.
0	2	95
10	10	95
20	20	95
30	30	95
35	35	90
40	40	70

MOTOR PROTECTION

External motor protection is not required.

MINIMUM INFLOW PRESSURE

Please determine the minimum inflow pressure for corresponding temperature from the following table.

Media temperature	< 75 °C	> 90 °C
Minimum inflow pressure	0.05 bar	0.45 bar

SOUND PRESSURE LEVEL

The sound pressure level is < 45 dB (A).

High efficiency pumps with LCD display, electronically controlled and protected against condensation

HEP Optimo L Geo series, G2 product group

TECHNICAL DATA

TYPE	CONNECTION PIPE	THREADED CONNECTION	FLANGE	INSTALLATION LENGTH (MM)	VOLTAGE / FREQUENCY	P1 (W)	I _{MAX} (A)	NET-WEIGHT (KG)	PRODUCT NO.	EEL
HEP OPTIMO L GEO 25-8.0 G180	1"	1½"	-	180	230 V 50/60 HZ	15 ... 180	0,90	5,5	0323-64208.8-72	≤ 0,23
HEP OPTIMO L GEO 25-10.0 G180	1"	1½"	-	180	230 V 50/60 HZ	15 ... 195	0,90	5,5	0323-64210.8-72	≤ 0,23
HEP OPTIMO L GEO 30-8.0 G180	1¼"	2"	-	180	230 V 50/60 HZ	15 ... 180	0,90	5,8	0324-64208.8-72	≤ 0,23
HEP OPTIMO L GEO 30-10.0 G180	1¼"	2"	-	180	230 V 50/60 HZ	15 ... 195	0,90	5,8	0324-64210.8-72	≤ 0,23
HEP OPTIMO L GEO 32-8.0 G220	-	-	DN 32	220	230 V 50/60 HZ	15 ... 180	0,90	9,5	0324-94208.8-72	≤ 0,23
HEP OPTIMO L GEO 32-10.0 G220	-	-	DN 32	220	230 V 50/60 HZ	15 ... 195	0,90	9,5	0324-94210.8-72	≤ 0,23
HEP OPTIMO L GEO 40-8.0 G220	-	-	DN 40	220	230 V 50/60 HZ	15 ... 180	0,90	9,5	0325-94208.8-72	≤ 0,23
HEP OPTIMO L GEO 40-10.0 G220	-	-	DN 40	220	230 V 50/60 HZ	15 ... 195	0,90	9,5	0325-94210.8-72	≤ 0,23

PROPORTIONAL PRESSURE

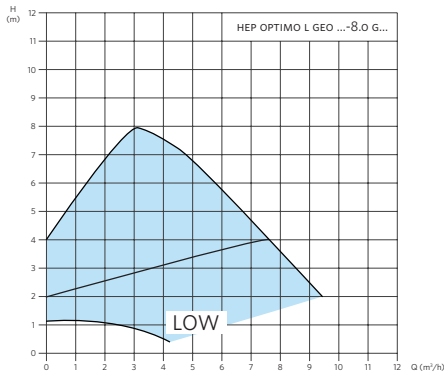

CONSTANT PRESSURE

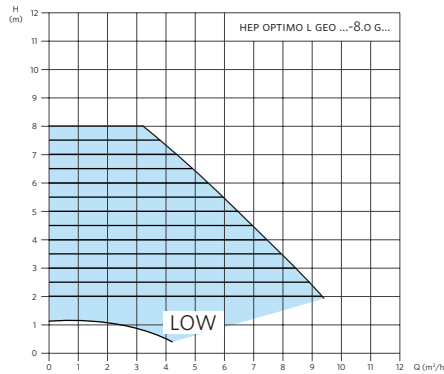

FIXED RPM

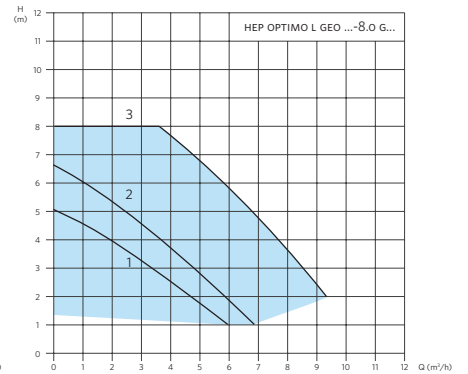

PROPORTIONAL PRESSURE

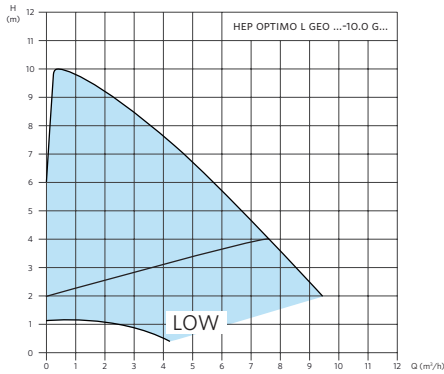

CONSTANT PRESSURE

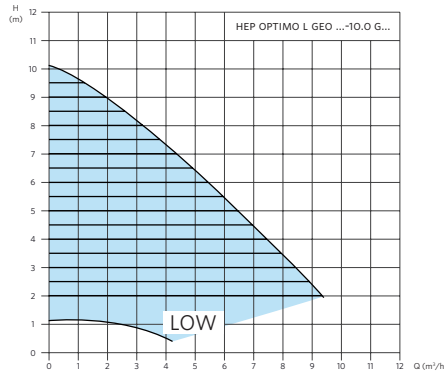

FIXED RPM

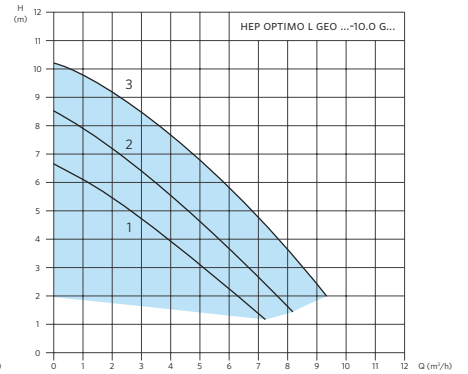

DIMENSIONS

TYPE	L1 (MM)	L2 (MM)	L3 (MM)	L4 (MM)
HEP OPTIMO L (THREAD)	180	267	178	225
HEP OPTIMO L (FLANGE)	220	267	177.5	245

DIMENSION ILLUSTRATION

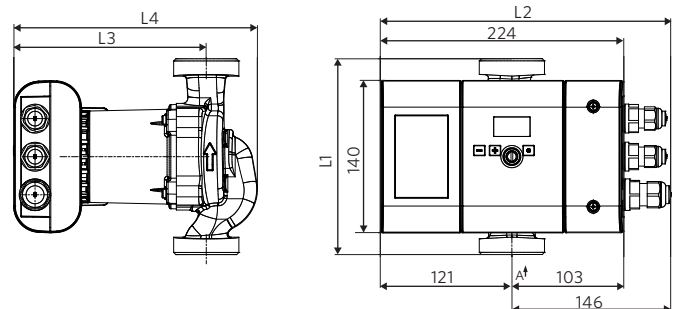

Condensate pump for gas condensing boilers up to 400 kW

Lift series, K1 product group



TECHNICAL DATA

Electrical connection:	230 V, 50/60 Hz
Input power:	65 W
Alarm contact:	max. 230 V, 8 A (resistive load), NO normally open/NC normally closed
Protection class:	IP 55
Medium:	condensate pH ≥ 3 , temperature 70 °C max
Rate of flow:	max. 350 l/h
Pressure head:	max. 4 m
Noise level:	max. 29 dB [A]
Dimensions:	185 x 85 x 100 mm (L x W x H)
Condensate supply:	\varnothing 24 mm
Condensate suction head:	83 mm
Tank:	ABS plastic, max. 0.5 l/0.13 Gal
Condensation drain:	nozzles for hose connection \varnothing 8 x 2 mm
Discharge hose:	included in the scope of delivery
Weight:	1.5 kg

PRODUCT FEATURES

- fully automatic condensate pump delivered completely ready for connection
- extremely quiet and vibration free
- very compact and space-saving construction
- fully encapsulated pump unit (IP 55) resistant to water jets from any direction
- pump unit also suitable for use in external tank (tank height min. 62 mm, max. 70 mm)
- integrated check valve for discharge hose
- condensation discharge hose (6 m, \varnothing 8 x 2 mm) included in delivery
- pre-mounted power cable (1.6 m) incl. shockproof plug
- overflow protection through separate float
- potential-free alarm connection (NO normally open/NC normally closed)
- pre-mounted alarm cable (0.9 m) incl. wall mounting

USE

The Lift condensate pump is a fully automatic unit for the extraction of condensate, produced in gas/oil condensing boilers, air-conditioning systems, refrigerated counters and dehumidifiers incl. collection tank. It can be used anywhere where a condensate disposal through gravity is not possible or where there is no direct drain. The Lift condensate pump is designed for gas condensing boilers up to 400 kW.

The housing is made from ABS plastic and is therefore resistant to acidic condensate (pH ≥ 3). For very acidic condensate (pH < 3), for the use of low-sulfur heating oil and for installations/systems with over 200 kW, it is compulsory according to ATV-DVWK-A 251 in Germany to install a neutralisation system (see condensate pump Lift NT25 resp. additional neutralisation tank NT50). Complementary municipal or other national regulations must be observed where necessary.

For the use in oil condensing boilers we recommend the additional use of an extension kit with activated carbon (see accessories for condensate pumps).

MAIN AREAS OF USE

- gas condensing boilers
 - oil condensing boilers
 - air-conditioning systems
 - refrigerators, refrigerated cabinets, refrigerated counters*
 - dehumidifiers, evaporators
- *) not suitable for splash water

FLOW MEDIA

- condensates with a pH ≥ 3 and a 70 °C max temperature.
- condensates with a pH over 3 have to be neutralized.
- condensates with oil residues from oil condensing boilers must be cleaned with activated carbon (extension kit) if necessary.

TEMPERATURE RANGE

Ambient temperature:	+5 °C to +45 °C
Media temperature:	+2 °C to +70 °C

SWITCHING POINTS

Alarm max.	55 mm
Start	52 +/- 1 mm
Stop	24 +/- 1 mm

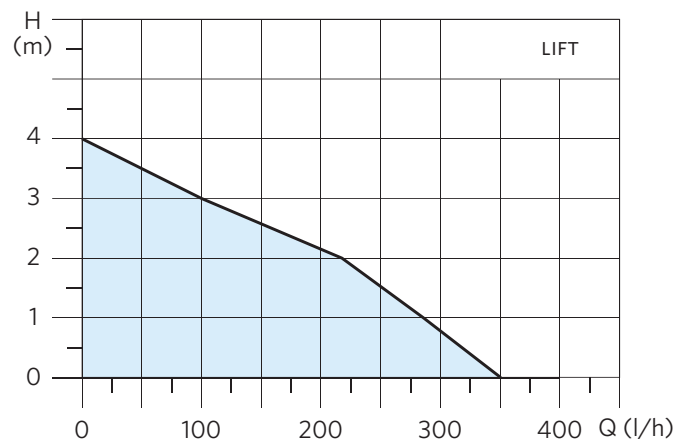

DELIVERY PROGRAM

TYPE	MAX PRESSURE HEAD	MAX RATE OF FLOW	FOR CONDENSING BOILERS UP TO	REMARKS	PRODUCT NO.
LIFT	4 M	350 L/H	400 KW	INCL. PRESSURE HOSE (6 M, \varnothing 8 x 2 MM)	0341-00400-72

Condensate pump for gas condensing boilers up to 300 kW

Lift Basic series, K1 product group



TECHNICAL DATA

Electrical connection:	230 V, 50/60 Hz
Input power:	65 W
Alarm contact:	max. 230 V, 8 A (resistive load), NO normally open/NC normally closed
Protection class:	IP 20
Medium:	condensate pH ≥ 3 , temperature 70 °C max
Rate of flow:	max. 200 l/h
Pressure head:	max. 4 m
Noise level:	max. 33 dB [A]
Dimensions:	200 x 105 x 160 mm (L x W x H)
Condensate supply:	\varnothing 24 mm
Condensate suction head:	77 mm
Tank:	ABS plastic, max. 1.0 l/0.26 Gal
Condensation drain:	nozzles for hose connection \varnothing 8 x 2 mm
Discharge hose:	included in the scope of delivery
Weight:	1.6 kg

PRODUCT FEATURES

- fully automatic condensate pump delivered completely ready for connection
- extremely quiet
- space-saving construction
- housing made from ABS plastics is resistant to condensate
- integrated check valve for discharge hose
- condensation discharge hose (6 m, \varnothing 8 x 2 mm) included in delivery
- pre-mounted power cable (1.6 m) incl. shockproof plug
- overflow protection through separate float
- potential-free alarm connection (NO normally open/NC normally closed)
- pre-mounted alarm cable (0.9 m) incl. wall mounting

USE

The Lift Basic condensate pump is a fully automatic unit for the extraction of condensate, produced in gas/oil condensing boilers, air-conditioning systems, refrigerated counters and dehumidifiers incl. collection tank. It can be used anywhere where a condensate disposal through gravity is not possible or where there is no direct drain. The Lift Basic condensate pump is designed for gas condensing boilers up to 300 kW.

The housing is made from ABS plastic and is therefore resistant to acidic condensate (pH ≥ 3). For very acidic condensate (pH < 3), for the use of low-sulfur heating oil and for installations/systems with over 200 kW, it is compulsory according to ATV-DVWK-A 251 in Germany to install a neutralisation system (see condensate pump Lift NT25 resp. additional neutralisation tank NT50). Complementary municipal or other national regulations must be observed where necessary.

For the use in oil condensing boilers we recommend the additional use of an extension kit with activated carbon (see accessories for condensate pumps).

MAIN AREAS OF USE

- gas condensing boilers
 - oil condensing boilers
 - air-conditioning systems
 - refrigerators, refrigerated cabinets, refrigerated counters*
 - dehumidifiers, evaporators
- *) not suitable for splash water

FLOW MEDIA

- condensates with a pH ≥ 3 and a 70 °C max temperature.
- condensates with a pH over 3 have to be neutralized.
- condensates with oil residues from oil condensing boilers must be cleaned with activated carbon (extension kit) if necessary.

TEMPERATURE RANGE

Ambient temperature:	+5 °C to +45 °C
Media temperature:	+2 °C to +70 °C

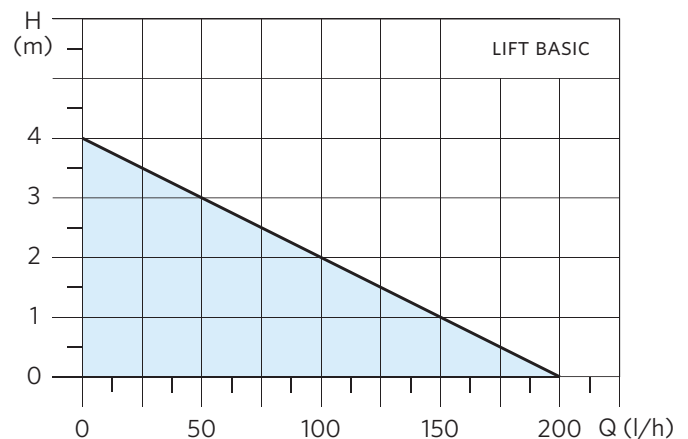

DELIVERY PROGRAM

TYPE	MAX PRESSURE HEAD	MAX RATE OF FLOW	FOR CONDENSING BOILERS UP TO	REMARKS	PRODUCT NO.
LIFT BASIC	4 M	200 L/H	300 KW	INCL. PRESSURE HOSE (6 M, \varnothing 8 x 2 MM)	0341-00300-72

Condensate pump for oil condensing boilers with neutralisation tank

Lift NT25 series, K1 product group



TECHNICAL DATA

Electrical connection:	230 V, 50/60 Hz
Input power:	40 W
Alarm contact:	max. 230 V, 8 A (resistive load), NO normally open/NC normally closed
Protection class:	IP 20
Medium:	condensate pH ≥ 3 , temperature 70 °C max
Rate of flow:	max. 14 l/h
Pressure head:	max. 10 m
Noise level:	max. 36 dB [A]
Dimensions:	244 x 174 x 261 mm (L x W x H)
Condensate supply:	\varnothing 40 mm
Condensate suction head:	200 mm
Neutralisation tank:	ABS plastic, 6.0 l/1.59 Gal, incl. neutralisation granulate (1 kg)
Condensation drain:	nozzles for hose connection \varnothing 8 x 2 mm
Weight:	2.7 kg

PRODUCT FEATURES

- fully automatic condensate pump delivered completely ready for connection, incl. neutralisation tank
- noise-reducing electronic controls with follow-up time to reduce switching frequency
- space-saving construction
- integrated collection/neutralisation tank, incl. first fill with neutralisation granulate (1 kg) - sufficient for about 12 months for systems up to 25 kW
- upstream suction filter as well as check valve for discharge hose
- connection for discharge hose (\varnothing 6 x 1.5 mm)
- pre-mounted power cable (1.0 m) incl. shockproof plug
- overflow protection through separate float
- potential-free alarm connection (NO normally open/NC normally closed)

USE

The Lift NT25 condensate pump is a fully automatic unit for the extraction of condensate, produced in gas/oil condensing boilers, air-conditioning systems, refrigerated counters and dehumidifiers incl. collection/neutralisation tank. It can be used anywhere where a condensate disposal through gravity is not possible or where there is no direct drain. The Lift NT25 condensate pump is designed for gas and oil condensing boilers up to 25 kW. It is extensible for systems up to 100 kW with additional accessories NB2 and NT50.

The housing is made from ABS plastic and is therefore resistant to acidic condensate (pH ≥ 3).

For the use in oil condensing boilers we recommend the additional use of an extensionkit with activated carbon (see accessories for condensate pumps).

SCHEMATIC SKETCH LIFT NT25

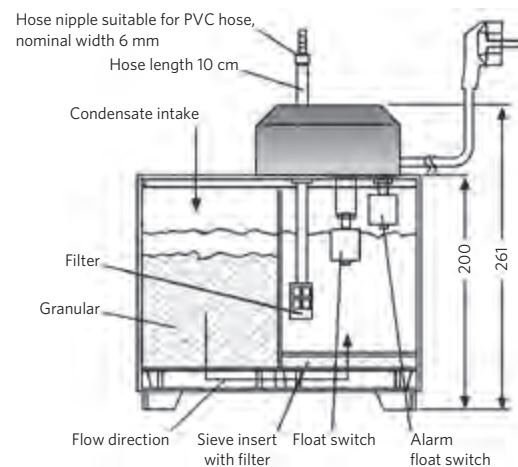

MAIN AREAS OF USE

- gas condensing boilers
- oil condensing boilers

FLOW MEDIA

- condensates produced in gas and oil condensing boilers with a 70 °C max temperature.
- condensates with oil residues from oil condensing boilers must be cleaned with activated carbon (extension kit) if necessary.

TEMPERATURE RANGE

Ambient temperature:	+5 °C to +45 °C
Media temperature:	+2 °C to +70 °C

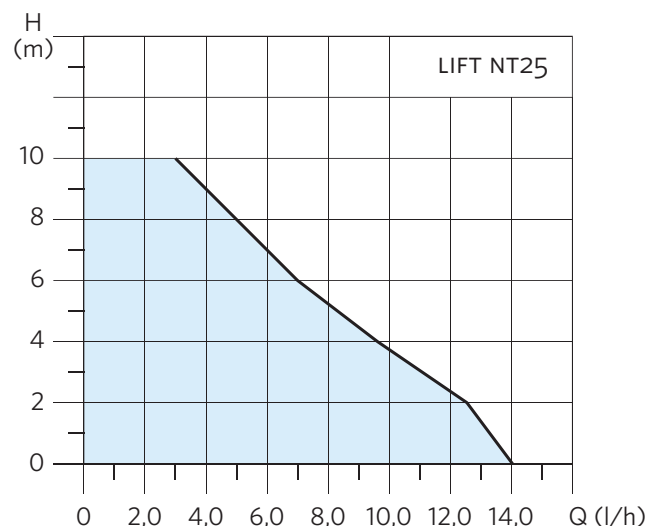

Condensate pump for oil condensing boilers with neutralisation tank

Lift NT25 series, K1 product group

DELIVERY PROGRAM

TYPE	MAX PRESSURE HEAD	MAX RATE OF FLOW	FOR CONDENSING BOILERS UP TO	REMARKS	PRODUCT NO.
LIFT NT25	10 M	14 L/H	25 KW	INCL. NEUTRALISATION TANK INCL. FIRST FILL WITH NEUTRALISATION GRANULATE	0341-00025-72

CONNECTION ALARM CABLE

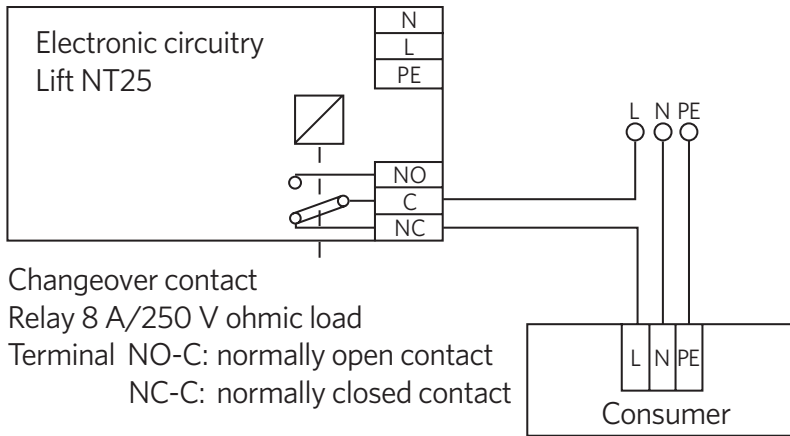

CONNECTION EXAMPLE FOR POTENTIAL-FREE CONTACT

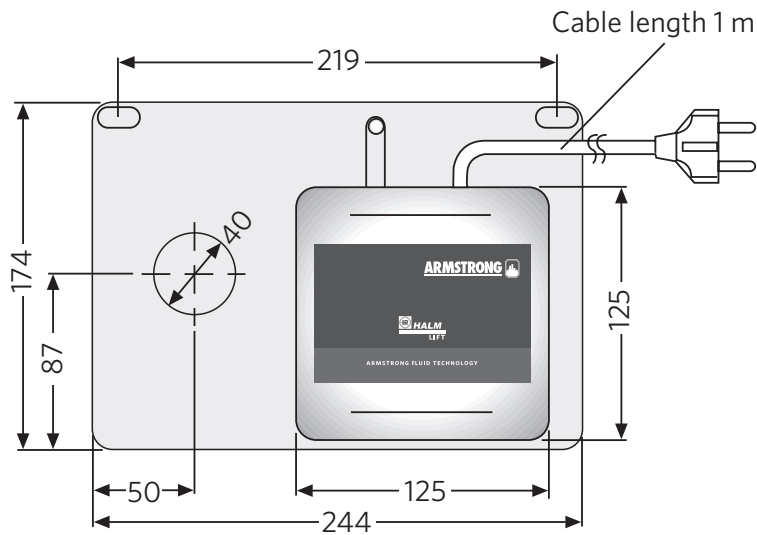

SCREW CONNECTIONS



TYPE	PRODUCT NO.	DESCRIPTION
GREY CAST IRON CONNECTION G 1"	4152-0001.1	1 SET C.I. CONNECTION RP 1/2" X G 1"
GREY CAST IRON CONNECTION G 1 1/4"	4152-0001.2	1 SET C.I. CONNECTION RP 3/4" X G 1 1/4"
GREY CAST IRON CONNECTION G 1 1/2"	4152-0001.3	1 SET C.I. CONNECTION RP 1" X G 1 1/2"
GREY CAST IRON CONNECTION G 2"	4152-0001.4	1 SET C.I. CONNECTION RP 1 1/4" X G 2"
BRASS CONNECTION G 1"	4152-0005.1	1 SET BRASS CONNECTION RP 1/2" X G 1"
BRASS CONNECTION G 1 1/4"	4152-0005.2	1 SET BRASS CONNECTION RP 3/4" X G 1 1/4"
BRASS CONNECTION G 1 1/2"	4152-0005.3	1 SET BRASS CONNECTION RP 1" X G 1 1/2"

FLANGE ADAPTORS FOR PIPE INSTALLATION (FLANGE)



TYPE	PRODUCT NO.	DESCRIPTION
FA 4030	4152-9006	1 FLANGE ADAPTOR GREY-CAST IRON (PN10) INCL. SCREWS + SEAL, DN40, 30 MM
FA 4070	4152-9007	1 FLANGE ADAPTOR GREY-CAST IRON (PN10) INCL. SCREWS + SEAL, DN40, 70 MM
FA 5010	4152-9008	1 FLANGE ADAPTOR GREY-CAST IRON (PN10) INCL. SCREWS + SEAL, DN50, 10 MM
FA 5020	4152-9009	1 FLANGE ADAPTOR GREY-CAST IRON (PN10) INCL. SCREWS + SEAL, DN50, 20 MM
FA 5050	4152-9010	1 FLANGE ADAPTOR GREY-CAST IRON (PN10) INCL. SCREWS + SEAL, DN50, 50 MM
FA 5060	4152-9011	1 FLANGE ADAPTOR GREY-CAST IRON (PN10) INCL. SCREWS + SEAL, DN50, 60 MM
FA 6510	4152-9012	1 FLANGE ADAPTOR GREY-CAST IRON (PN10) INCL. SCREWS + SEAL, DN65, 10 MM
FA 6525	4152-9013	1 FLANGE ADAPTOR GREY-CAST IRON (PN10) INCL. SCREWS + SEAL, DN65, 25 MM
FA 6530	4152-9014	1 FLANGE ADAPTOR GREY-CAST IRON (PN10) INCL. SCREWS + SEAL, DN65, 30 MM

INSULATION SHELL/INSULATION SHELL FOR COLD WATER APPLICATIONS



TYPE	PRODUCT NO.	DESCRIPTION
WDS A 180	4152-0100	INSULATION SHELL FOR HEP OPTIMO (BASIC) WITH INSTALLATION LENGTH 180 MM
WDS B 180	4152-0113	INSULATION SHELL FOR HEP OPTIMO L WITH INSTALLATION LENGTH 180 MM
WDS C 25/30	4152-0114	INSULATION SHELL FOR HEP OPTIMO L+ WITH CONNECTION G 1 1/2" AND 2"
WDS C 32-12.0	4152-0115	INSULATION SHELL FOR HEP OPTIMO L+ 32-12.0
WDS C 40-6.0	4152-0116	INSULATION SHELL FOR HEP OPTIMO L+ 40-6.0
WDS C 40-8.0/10.0	4152-0117	INSULATION SHELL FOR HEP OPTIMO L+ 40-8.0/10.0
WDS C 40-12.0/50-10.0/12.0	4152-0118	INSULATION SHELL FOR HEP OPTIMO L+ 40-12.0 AND 50-10.0/12.0
WDS C 50-6.0/8.0	4152-0119	INSULATION SHELL FOR HEP OPTIMO L+ 50-6.0/8.0
WDS C 65-6.0	4152-0120	INSULATION SHELL FOR HEP OPTIMO L+ 65-6.0
WDS C 65-12.0	4152-0121	INSULATION SHELL FOR HEP OPTIMO L+ 65-12.0
KDS C 25-6/8/10 30-6/8/10	4152-0122	INSULATION SHELL FOR COLD WATER APPLICATIONS FOR HEP OPTIMO L+ 25-6.0/8.0/10.0 AND 30-6.0/8.0/10.0
KDS C 40-6.0	4152-0123	INSULATION SHELL FOR COLD WATER APPLICATIONS FOR HEP OPTIMO L+ 40-6.0

PLUG



TYPE	PRODUCT NO.	DESCRIPTION
PLUG COMPLETE	3219-2205-01	PLUG FOR SERIES HEP COMPLETE INCL. SOCKET ON MOTOR SIDE
SOCKET ONLY (NOT SHOWN)	3219-2204	SOCKET ON MOTOR SIDE FOR PLUG FOR SERIES HEP

Further accessories and spare parts on request.

Accessories/Spare parts for condensate pumps

Z2 product group

MAINTENANCE KIT FOR LIFT NT25

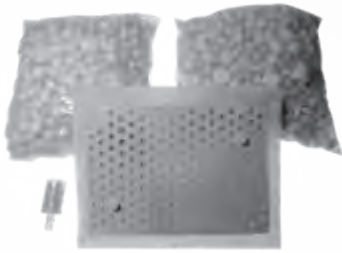

TYPE	PRODUCT NO.	DESCRIPTION
MAINTENANCE KIT FOR LIFT NT25	4152-0107	MAINTENANCE KIT FOR LIFT NT25 FOR THE YEARLY MAINTENANCE CONSISTING OF NEUTRALISATION GRANULATE (2 KG), REPLACEMENT FILTER SIEVE WITH FLEECE, REPLACEMENT FILTER ELEMENT FOR SUCTION FILTERS.

EXTENSION KIT OIL CONDENSING BOILERS



TYPE	PRODUCT NO.	DESCRIPTION
EXTENSION KIT OIL CONDENSING BOILERS	4152-0108	EXTENSION KIT FOR LIFT NT25 FOR OIL CONDENSING BOILERS CONSISTING OF ACTIVATED CARBON FILTER AND SIEVE.

NT50



TYPE	PRODUCT NO.	DESCRIPTION
NT50	4152-0109	ADDITIONAL COLLECTION/NEUTRALISATION TANK WITH GRANULATE (2 X 2 KG) FOR NEUTRALISATION CAPACITY 50 KW, FILTER SIEVES (2X) AND CONNECTION/NOZZLE FOR THE CONNECTION TO THE LIFT NT25. CONDENSATE SUPPLY OPENING Ø40 MM/CONDENSATE SUPPLY HEIGHT 200 MM.

NG2



TYPE	PRODUCT NO.	DESCRIPTION
NG2	4152-0110	REFILL PACK NEUTRALISATION GRANULATE (2 KG)

ALARM PLUS



TYPE	PRODUCT NO.	DESCRIPTION
ALARM PLUS	4152-0111	AUDIO AND VISUAL FAULT INDICATOR FOR THE ALARM OUTPUT OF THE CONDENSATE PUMP (230 V, 50/60 HZ) FOR THE CONNECTION TO THE CONDENSATE PUMP WITH ALARM RELAY OUTPUT, 56 X 88 X 51 MM (L X W X H), INPUT POWER 1.9 W, IP 20, AMBIENT TEMPERATURE +5 °C TO +50 °C.

Further accessories and spare parts on request.

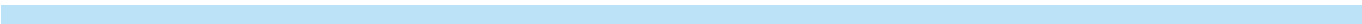

Notes

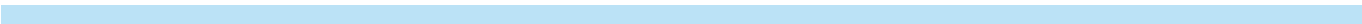

Notes



IN CASE OF QUESTIONS OR FOR ORDERS,
PLEASE CONTACT US AT

GERMANY@ARMSTRONGFLUIDTECHNOLOGY.COM

FOR MORE INFORMATION, PLEASE GO TO

WWW.HALM-PUMPS.DE

TORONTO, CANADA

+1 416 755 2291

BUFFALO, USA

+1 716 693 8813

SÃO PAULO, BRAZIL

+55 (11) 4781 5500

BIRMINGHAM, UK

+44 (0) 8444 145 145

MANCHESTER, UK

+44 (0) 8444 145 145

LYON, FRANCE

+33 (0) 420 102 625

MANNHEIM, GERMANY

+49 (0) 621 3999 9858

DUBAI, UAE

+971 4 8876775

BANGALORE, INDIA

+91 (0) 80 4906 3555

SHANGHAI, CHINA

+86 (0) 21 3756 6696

ARMSTRONG FLUID TECHNOLOGY
ESTABLISHED 1934

ARMSTRONGFLUIDTECHNOLOGY.COM

**MAKING
ENERGY
MAKE
SENSE™**