

# High efficiency pumps with LCD display, electronically controlled

HEP Optimo L+ series, H2 product group



Insulation shell included in delivery.

**5 YEAR WARRANTY**  
★★★★★

**BEST in class**

**ERP 2015+**

**BAFA GEFÖRDERT**

## TECHNICAL DATA

Rate of flow: 7 to 45 m<sup>3</sup>/h depending on model  
 Pressure head: 6 m/8 m/10 m/12 m  
 Control range: 6 to 760 W depending on model  
 Media temperature: -10 °C (non freezing) to +110 °C  
 Installation length: 180 to 340 mm depending on model  
 Circulator connection: 1½" and 2" (threaded)  
 DN 32, 40, 50 and 65 (flanged)  
 Protection class: IP 44  
 Insulation class: F  
 Nominal pressure: PN 10

## Control

Internal: Δpc + Δpv + Eco Mode + fixed rpm  
 External: analogue 0-10 V  
 Start/Stop (bridged terminal ex works)

Omnibus fault message: Selector switch, potential free.

## PRODUCT FEATURES

- High-efficiency wet running circulator with integrated automatic modes and additional eco mode for additional savings of approx. 40% compared to the best proportional pressure control.
- Convenient operation with multi-knob and dip switch.
- Optional night mode and locking against unauthorized adjustment.
- Clear display of function, setting and operating status via backlit icons and LCD display.
- Connection possibility of external control (0-10 V, start/stop signal) and omnibus fault indication.
- Numerous integrated additional functions (autom. air ventilation, soft-start/inrush current limitation, anti blockage function, electronic motor protection against thermal overload).
- High-quality manufacturing and standard insulation shells.

## USE

The wet-running high-efficiency circulators HEP Optimo L+ have an electronically commutated synchronous motor with permanent magnet rotor and a continuously variable differential pressure control. They are designed for use in circulating systems with variable or constant flow. The inline pump housings are resistant to corrosion by a cathodic electrodeposition coating. The HEP Optimo L+ are designed for a static operating pressure of 10 bar.

## MAIN AREAS OF USE

Heating, air conditioning/refrigeration, solar, heat pumps and industrial facilities as

- dual pipe system
- boiler and primary circuit
- single pipe system
- storage loading circuit
- panel systems like underfloor heating

## CONTROLS FUNCTION

With the multi-function button, all settings can be made easily and quickly. The multi-function button consists of an outer dial for the selection of the desired mode and the power set values, and an internal activation pushbutton for the programming start and for the confirmation of the selected mode or the power set point. Lit symbols in the motor cap

indicate which mode has been active or selected. By pressing the activation pushbutton for more than 30 seconds, the pump is reset to factory default settings. 10 LED segments located around the outer dial show blue enlightened for the selected power values (10-100% of maximum curve). The display shows alternately head, flow rate and power consumption. In cases of disturbances the icon SERVICE lights and additional error codes shown on the display enable a rapid troubleshooting. DIP switches located in the Circulator terminal box can be used optionally for locking against unauthorized adjustment and/or for an activation of the night setback mode.

## MATERIALS

Component	Material	Material no.
Pump housing	Grey cast iron, KTL	EN-GJL-200
Impeller	Plastic with fiberglass	PSU-GF30
Shaft	Stainless steel	1.4034
Bearing	Ceramic/Graphite	
Can	Stainless steel	1.4301
Insulation shell	Polypropylen	

## FLOW MEDIA

- heating water as per VDI 2035
- pure, thin, non-aggressive and non-explosive, mineral oil-free media without solid or long-fibre components
- media with a max. viscosity of 10 mm<sup>2</sup>/s
- operating data must be checked above 20 % glycol

## TEMPERATURE RANGE

Ambient temperature: 0 °C to +40 °C  
 Temperature class: TF 110  
 Media temperature: -10 °C (non-freezing) to +110 °C

## AMBIENT TEMPERATURE

To avoid condensation on the pump housing, the media temperature should always be equal to or higher than the ambient temperature (see table).

Otherwise, as well as for temperatures from -10 °C to +5 °C, we recommend using a diffusion-tight insulation shell (see accessories).

Ambient temperature	Media temperature min.	Media temperature max.
0 °C	2 °C	110 °C
10 °C	10 °C	110 °C
20 °C	20 °C	110 °C
30 °C	30 °C	110 °C
35 °C	35 °C	100 °C
40 °C	40 °C	90 °C

## MOTOR PROTECTION

An external motor protection is not required. The integrated electronic motor protection automatically reduces the power at overload. Simultaneously, a warning appears on the display.

## MINIMUM INFLOW PRESSURE

To avoid cavitation noise and circulator damage the following minimum inlet pressure must be maintained at the pump suction nozzle. The values apply up to 300 m above sea level. Otherwise, a surcharge of 0.01 bar per 100 m time should be added.

Media temperature	< 80 °C	> 80 °C to < 95 °C
Minimum inflow pressure	0,5 bar	1,5 bar

## SOUND PRESSURE LEVEL

The sound pressure level is ≤ 45 dB (A).

# High efficiency pumps with LCD display, electronically controlled

HEP Optimo L+ series, H2 product group

## Technical data

TYPE	CONNECTION PIPE	THREADED CONNECTION	FLANGE	INSTALLATION LENGTH (MM)	VOLTAGE / FREQUENCY	P1 (W)	I <sub>MAX</sub> (A)	NET-WEIGHT (KG)	PRODUCT NO.	EEL
HEP OPTIMO L+ 25-6.0 G180	1"	1 1/2"		180	230 V 50/60 HZ	6 ... 112	0.03 ... 0.50	4.6	0323-92060-072	≤ 0.20
HEP OPTIMO L+ 25-8.0 G180	1"	1 1/2"		180	230 V 50/60 HZ	6 ... 145	0.03 ... 0.63	4.6	0323-92080-072	≤ 0.20
HEP OPTIMO L+ 25-10.0 G180	1"	1 1/2"		180	230 V 50/60 HZ	6 ... 175	0.03 ... 0.80	4.6	0323-92100-072	≤ 0.20
HEP OPTIMO L+ 30-6.0 G180	1 1/4"	2"		180	230 V 50/60 HZ	6 ... 112	0.03 ... 0.50	5.1	0324-92060-072	≤ 0.20
HEP OPTIMO L+ 30-8.0 G180	1 1/4"	2"		180	230 V 50/60 HZ	6 ... 145	0.03 ... 0.63	5.1	0324-92080-072	≤ 0.20
HEP OPTIMO L+ 30-10.0 G180	1 1/4"	2"		180	230 V 50/60 HZ	6 ... 175	0.03 ... 0.80	5.1	0324-92100-072	≤ 0.20
HEP OPTIMO L+ 30-12.0 G180	1 1/4"	2"		180	230 V 50/60 HZ	9 ... 350	0.04 ... 1.50	6.4	0324-92120-072	≤ 0.20
HEP OPTIMO L+ 32-12.0 G220			DN 32	220	230 V 50/60 HZ	9 ... 350	0.04 ... 1.50	9.3	0324-93120-072	≤ 0.20
HEP OPTIMO L+ 40-6.0 G220			DN 40	220	230 V 50/60 HZ	7 ... 110	0.03 ... 0.48	8.0	0325-93060-072	≤ 0.20
HEP OPTIMO L+ 40-8.0 G220			DN 40	220	230 V 50/60 HZ	10 ... 265	0.04 ... 1.15	11.1	0325-93080-072	≤ 0.20
HEP OPTIMO L+ 40-10.0 G220			DN 40	220	230 V 50/60 HZ	10 ... 350	0.04 ... 1.50	11.1	0325-93100-072	≤ 0.20
HEP OPTIMO L+ 40-12.0 G250			DN 40	250	230 V 50/60 HZ	46 ... 611	0.20 ... 2.70	20.3	0325-93120-072	≤ 0.20
HEP OPTIMO L+ 50-6.0 G240			DN 50	240	230 V 50/60 HZ	10 ... 275	0.04 ... 1.20	12.6	0326-93060-072	≤ 0.20
HEP OPTIMO L+ 50-8.0 G240			DN 50	240	230 V 50/60 HZ	10 ... 350	0.04 ... 1.50	12.6	0326-93080-072	≤ 0.20
HEP OPTIMO L+ 50-10.0 G280			DN 50	280	230 V 50/60 HZ	38 ... 476	0.16 ... 2.10	21.0	0326-93100-072	≤ 0.20
HEP OPTIMO L+ 50-12.0 G280			DN 50	280	230 V 50/60 HZ	46 ... 620	0.20 ... 2.70	21.0	0326-93120-072	≤ 0.20
HEP OPTIMO L+ 65-6.0 G340			DN 65	340	230 V 50/60 HZ	15 ... 350	0.07 ... 1.50	16.6	0327-93060-072	≤ 0.20
HEP OPTIMO L+ 65-12.0 G340			DN 65	340	230 V 50/60 HZ	55 ... 760	0.24 ... 3.30	29.5	0327-93120-072	≤ 0.20

## PERFORMANCE CURVES

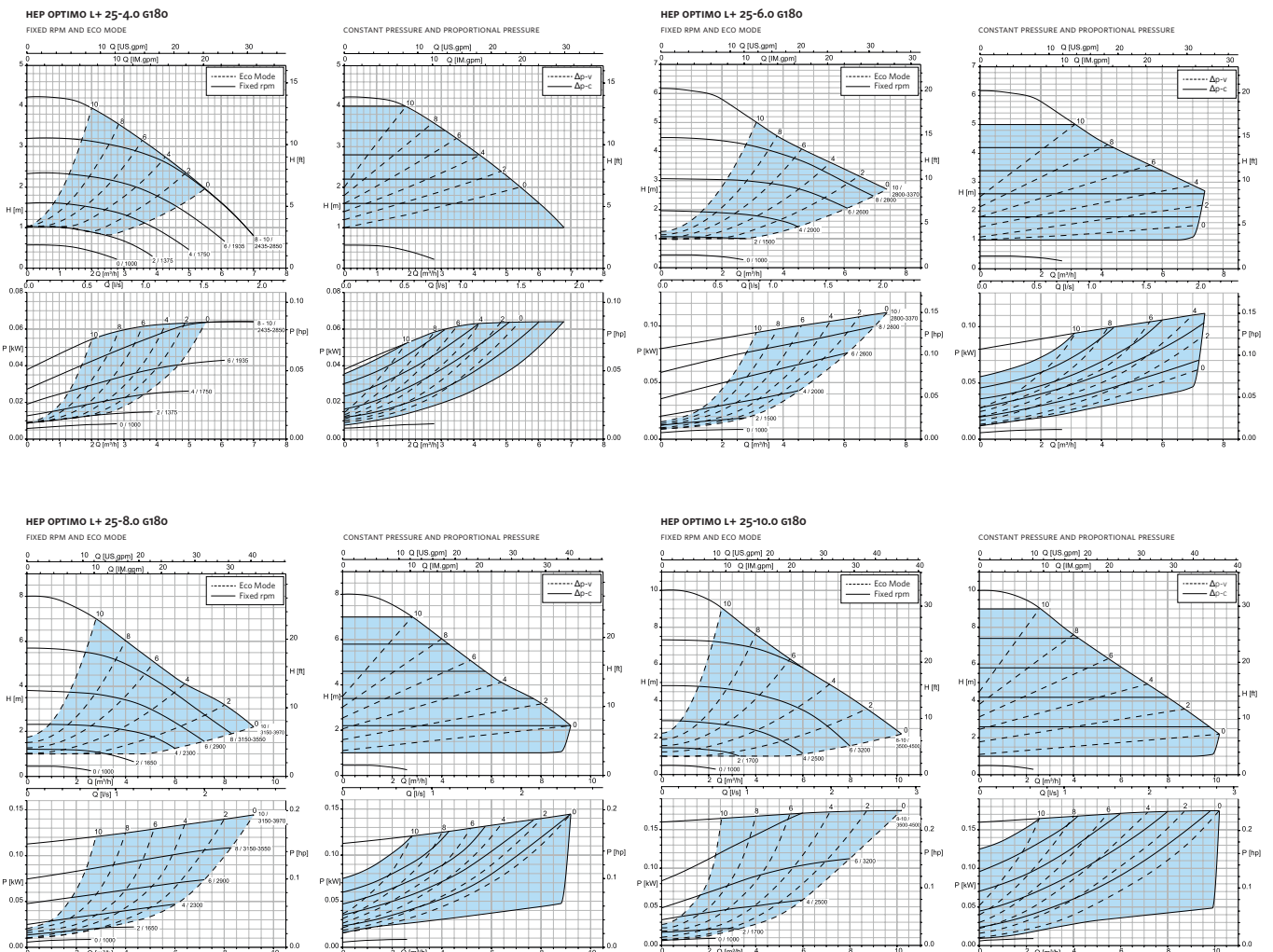

# High efficiency pumps with LCD display, electronically controlled

HEP Optimo L+ series, H2 product group

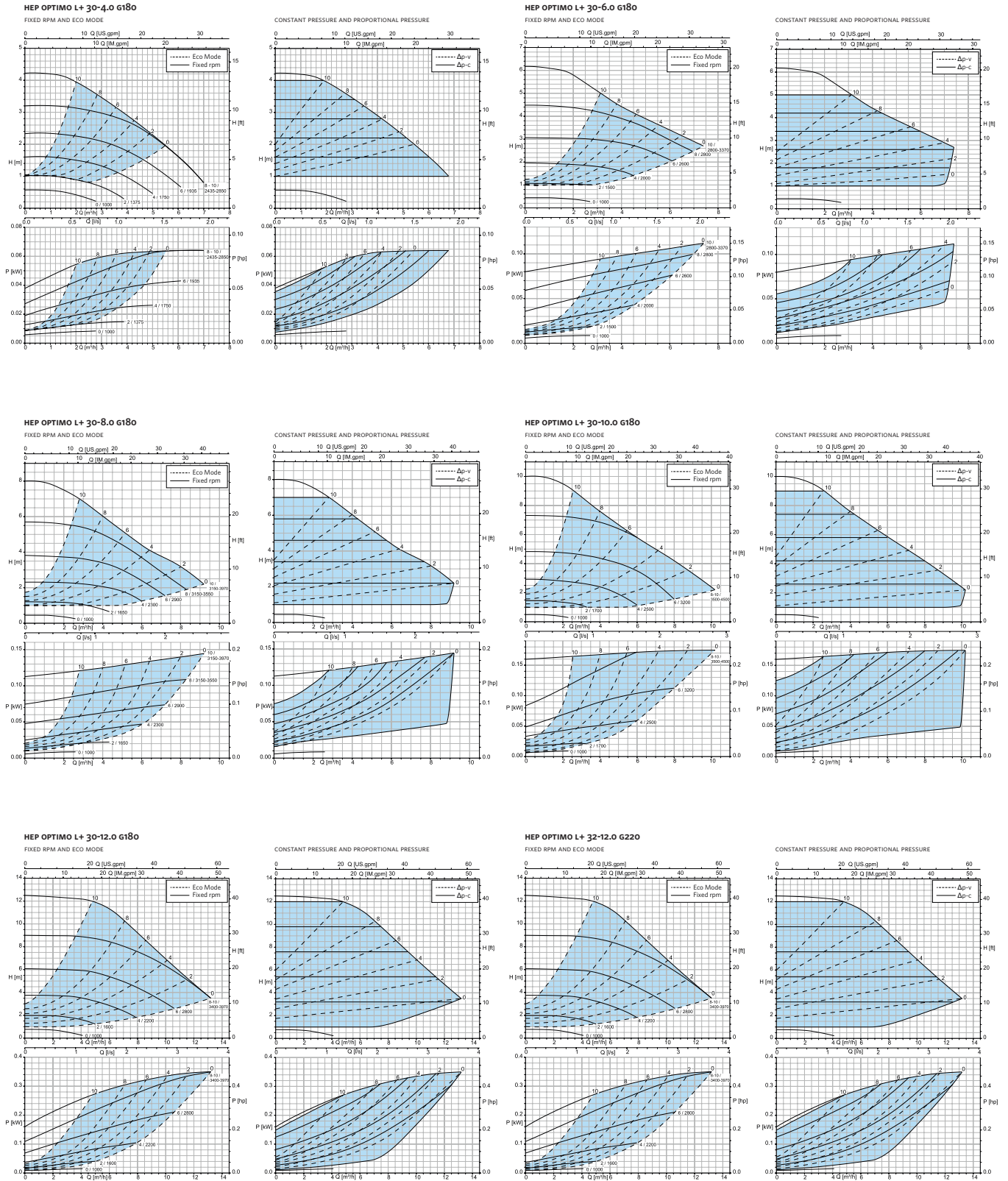

# High efficiency pumps with LCD display, electronically controlled

HEP Optimo L+ series, H2 product group

**HEP OPTIMO L+ 40-6.0 G220**

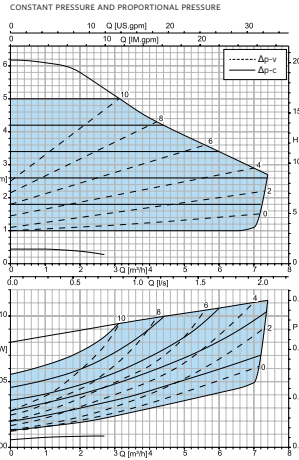
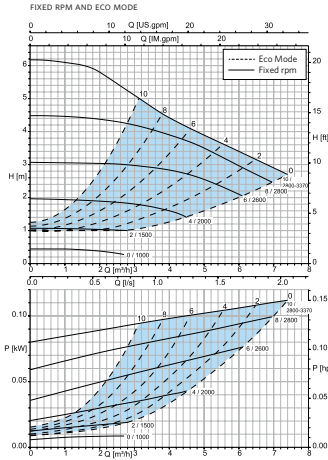

**HEP OPTIMO L+ 40-8.0 G220**

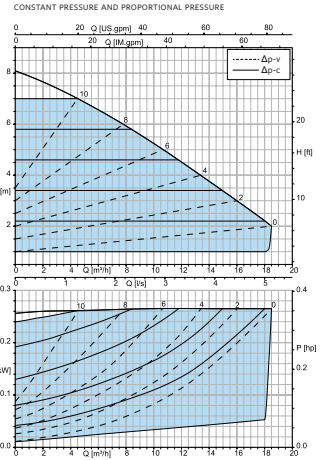
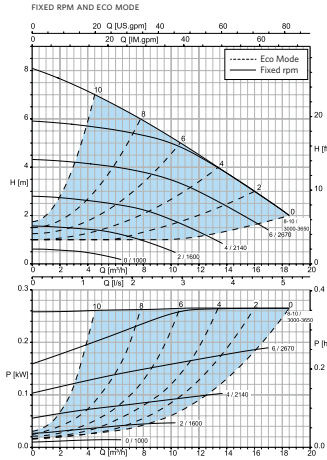

**HEP OPTIMO L+ 40-10.0 G220**

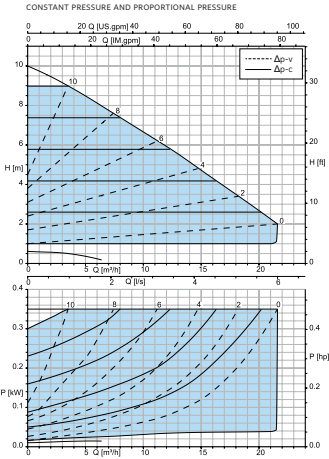
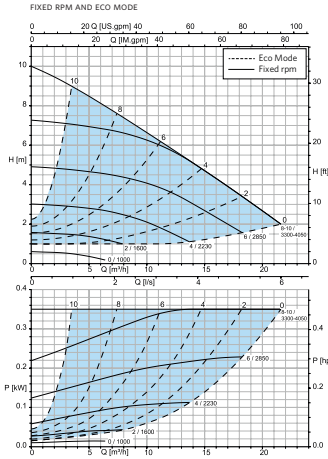

**HEP OPTIMO L+ 40-12.0 G250**

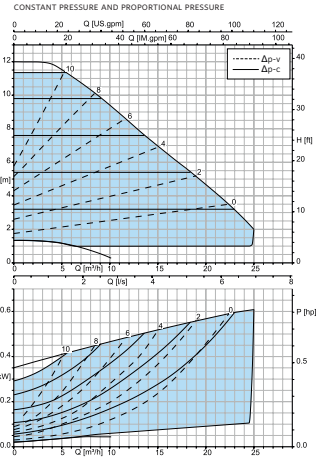
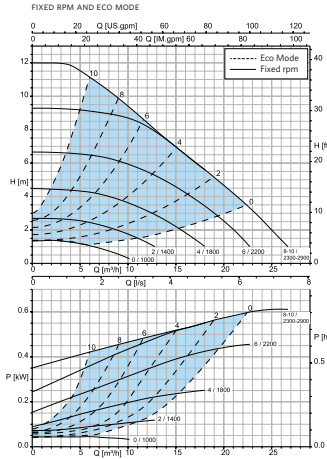

**HEP OPTIMO L+ 50-6.0 G240**

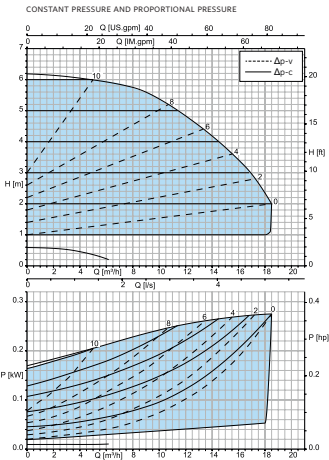
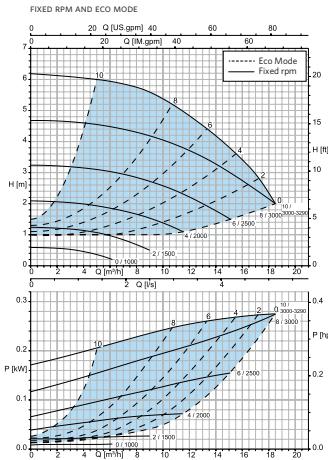

**HEP OPTIMO L+ 50-8.0 G240**

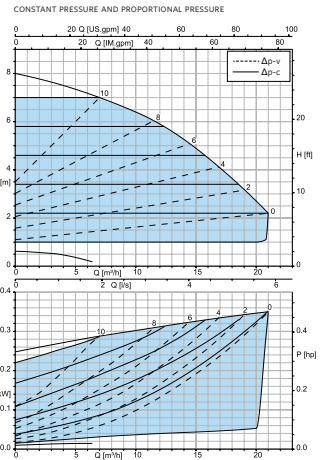
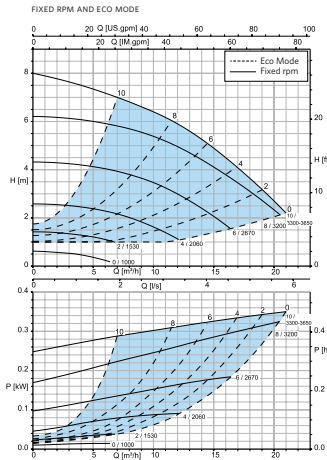



# High efficiency pumps with LCD display, electronically controlled

HEP Optimo L+ series, H2 product group

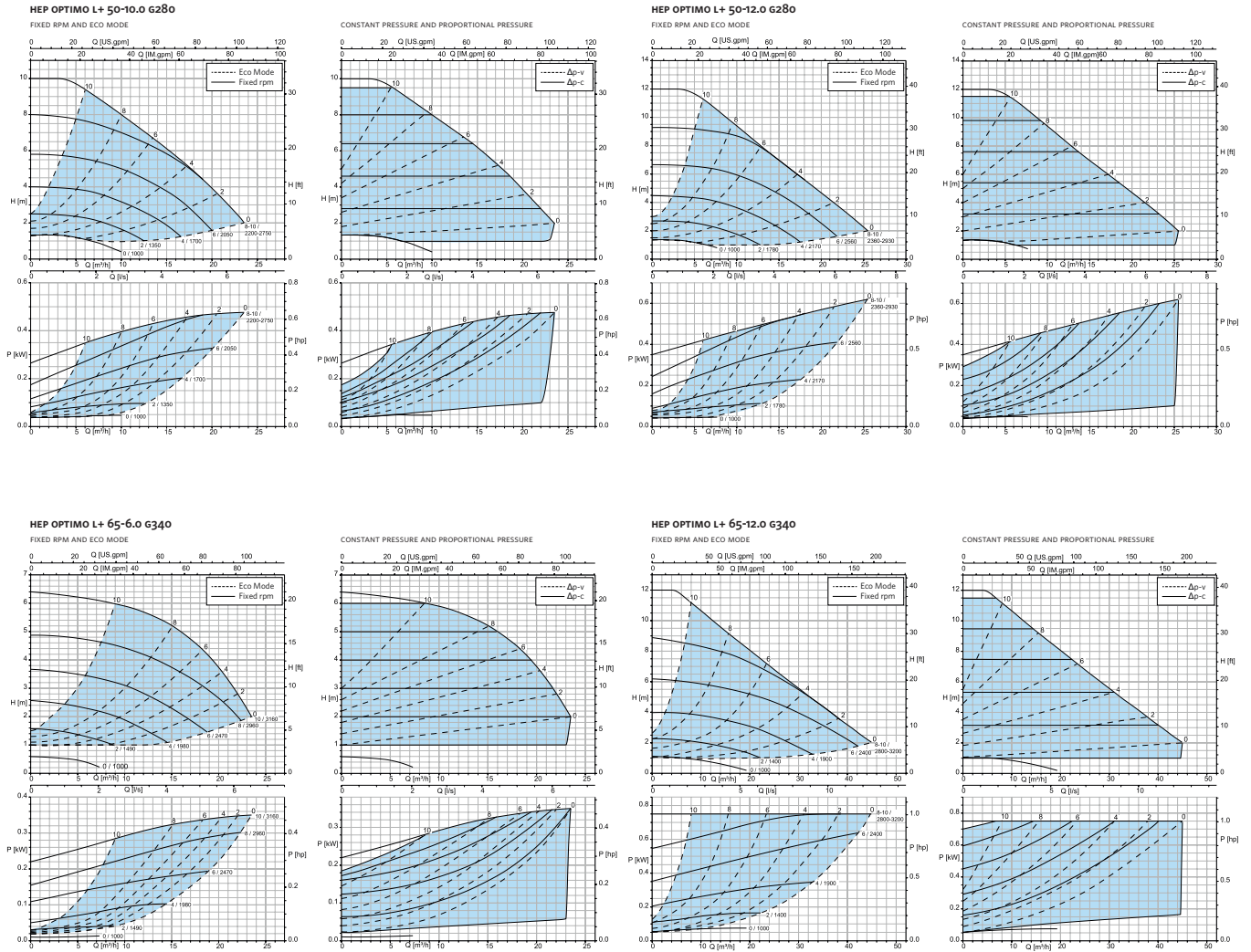

# High efficiency pumps with LCD display, electronically controlled

HEP Optimo L+ series, H2 product group

## DIMENSIONS (FLANGE DIMENSIONS IN MM)

COMBINATION FLANGES	PN 6			PN 10		
	ØD	ØK	N x D2	ØD	ØK	N x D2
DN 32	120	90	4 x Ø14	140	100	4 x Ø19
DN 40	130	100	4 x Ø14	150	110	4 x Ø19
DN 50	140	110	4 x Ø14	165	125	4 x Ø19
DN 65	160	130	4 x Ø14	185	145	4 x Ø19

## DIMENSION ILLUSTRATION

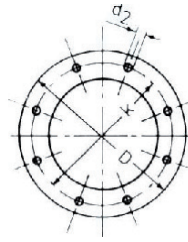

## DIMENSIONS (CIRCULATOR DIMENSIONS IN MM)

TYPE	A (MM)	B (MM)	C (MM)	D (MM)	E (MM)	F (MM)
HEP OPTIMO L+ 25-6.0 G180	192	53	102	180	140	160
HEP OPTIMO L+ 25-8.0 G180	192	53	102	180	140	160
HEP OPTIMO L+ 25-10.0 G180	192	53	102	180	140	160
HEP OPTIMO L+ 30-6.0 G180	192	53	102	180	140	160
HEP OPTIMO L+ 30-8.0 G180	192	53	102	180	140	160
HEP OPTIMO L+ 30-10.0 G180	192	53	102	180	140	160
HEP OPTIMO L+ 30-12.0 G180	245	56	98	180	140	160
HEP OPTIMO L+ 32-12.0 G220	245	65	110	220	140	160
HEP OPTIMO L+ 40-6.0 G220	192	70	110	220	140	160
HEP OPTIMO L+ 40-8.0 G220	192	70	120	220	140	160
HEP OPTIMO L+ 40-10.0 G220	255	70	120	220	140	160
HEP OPTIMO L+ 40-12.0 G250	382	76	135	250	206	240
HEP OPTIMO L+ 50-6.0 G240	256	78	130	240	140	160
HEP OPTIMO L+ 50-8.0 G240	256	78	130	240	140	160
HEP OPTIMO L+ 50-10.0 G280	382	77	140	280	206	240
HEP OPTIMO L+ 50-12.0 G280	382	77	140	280	206	240
HEP OPTIMO L+ 65-6.0 G340	257	89	170	340	140	160
HEP OPTIMO L+ 65-12.0 G340	387	100	170	340	206	240

## DIMENSION ILLUSTRATION (THREADED VERSION)

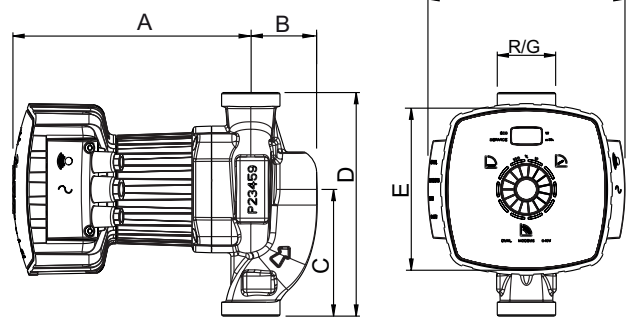

## DIMENSION ILLUSTRATION (FLANGE VERSION)

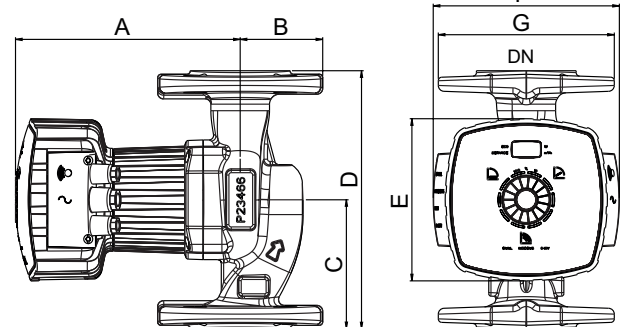



IN CASE OF QUESTIONS OR FOR ORDERS,  
PLEASE CONTACT US AT

[GERMANY@ARMSTRONGFLUIDTECHNOLOGY.COM](mailto:GERMANY@ARMSTRONGFLUIDTECHNOLOGY.COM)

FOR MORE INFORMATION, PLEASE GO TO

[WWW.HALM-PUMPS.DE](http://WWW.HALM-PUMPS.DE)

**TORONTO, CANADA**

+1 416 755 2291

**BUFFALO, USA**

+1 716 693 8813

**SÃO PAULO, BRAZIL**

+55 (11) 4781 5500

**BIRMINGHAM, UK**

+44 (0) 8444 145 145

**MANCHESTER, UK**

+44 (0) 8444 145 145

**LYON, FRANCE**

+33 (0) 420 102 625

**MANNHEIM, GERMANY**

+49 (0) 621 3999 9858

**DUBAI, UAE**

+971 4 8876775

**BANGALORE, INDIA**

+91 (0) 80 4906 3555

**SHANGHAI, CHINA**

+86 (0) 21 3756 6696

**ARMSTRONG FLUID TECHNOLOGY**  
ESTABLISHED 1934

**ARMSTRONGFLUIDTECHNOLOGY.COM**

**MAKING  
ENERGY  
MAKE  
SENSE™**

FILE NO.: 11.255DE-EN  
DATE: NOV. 23, 2018

SUPERSEDES: NEW  
DATE: NEW